

**RISCALDAMENTO**  
**HEATING**  
**HEIZUNG**  
**CHAUFFAGE**  
**ОБОРУДОВАНИЕ ДЛЯ СИСТЕМ ОТОПЛЕНИЯ**





## Collettori Manifolds

Collettori Inox - AvantFloor / Inox Manifolds - AvantFloor	p. 5
Multiklima distribuzione / Multiklima distribution	p. 21
Gruppi di miscelazione / Mixing units	p. 31
Collettori Inox - AvantFloor - Accessori / Inox Manifolds AvantFloor - Accessories	p. 34
Collettori Industriali - IVR Inox / Industrial Manifolds - IVR Inox	p. 42
Collettori Industriali - IVR Inox - Accessori / Industrial Manifolds - IVR Inox - Accessories	p. 46
Collettori in Ottone - SunnyFloor / Brass Manifolds - SunnyFloor	p. 48



## IVR Multiklima

Multiklima contabilizzazione / Multiklima energy metering	p. 58
---	-------



## Valvole per radiatori Radiator valves

Valvole Termostatiche / Thermostatic Valves	p. 65
Kit termostatici - Thermostatic kits	p. 81
Valvole Manuali / Manual Valves	p. 86
Valvole ad "H" / "H" valves	p. 97
Valvole Fan-coil / Fan-coil valves	p. 99
Adattatori / Adapters	p. 100



## Componenti centrale termica Components for Central Heating System

Gruppo Alimentazione / Automatic filling unit	p. 101
Valvole di bilanciamento / Balancing valves	p. 102
Gruppi valvole di Sicurezza e scarico caldaia / Safety Valves	p. 104
Rubinetti scarico caldaia / Boiler blow-off valves	p. 108

**COLLETTORI / MANIFOLDS**  
Collettori Inox / Inox Manifolds  
AVANT FLOOR



Collettore in acciaio inox AISI 304 1" - 1"1/4; Connessioni 3/4" EK - Zanche di fissaggio antivibrazione - Interasse 50 mm - Etichette e istruzioni  
AISI 304 stainless steel manifold 1" - 1"1/4; 3/4" Eurocone connections - Mounting brackets which minimise noise and vibration - Centre hole distance 50 mm - Stickers and assembly instruction  
Verteiler aus rostfreiem Edelstahl AISI 304 mit 1" - 1" 1/4; 3/4" Anschlüssen Eurokonus, schwingungsdämpfenden Befestigungs-Klammern, Abstand 50 mm - Etiketten und Anweisungen  
Collecteur en acier inox AISI 304 1" - 1"1/4; fixations 3/4" EK. Plaques d'ancrage antivibration Entraxes 50 mm Étiquettes et instructions  
Коллектор из нержавеющей стали AISI 304, размеры 1" - 1"1/4; 3/4", соединения Евроконус, межосевое расстояние 50 мм, крепления с защитой от вибрации, инструкция по сборке

**KIT A 802 IVR**

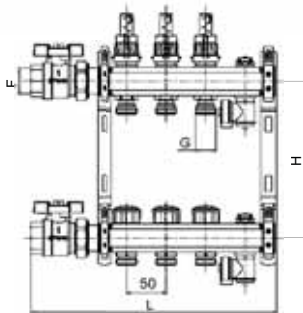

Collettore di mandata con misuratori di portata, valvola sfogo aria, rubinetto di carico/scarico acqua e valvola a sfera. Collettore di ritorno con valvole termostattizzabili, cappellotti di regolazione, valvola sfogo aria, rubinetto di carico/scarico acqua e valvola a sfera, tappi inclusi, con zanche di fissaggio

Inlet manifold with flow meters, air vent, fill & drain valve and ball valve. Return manifold with thermostatic valves, operating plastic caps, air vent, fill & drain valve and ball valve, plugs included, with mounting brackets

Vorlaufverteiler mit Durchflussmessern, Luftablassventil und Ein-/Ablassventil, Ein-/Ablassventil und Kugelhahn. Rücklaufverteiler mit thermostatisierbaren Ventilen, Einstellkappen, Luftablassventil und Ein-/Ablassventil und Kugelhahn - Stopfen inklusive, mit Befestigungsklammern

Collecteur d'alimentation avec mesureurs de débit, vanne de purge de l'air, robinet de chargement/déchargement et vanne à boisseau sphérique. Collecteur de retour avec vannes thermostatisables, chapeaux de réglage, vanne de purge de l'air, robinet de chargement/déchargement et vanne à boisseau sphérique, bouchons et plaques d'ancrage inclus

Входной коллектор с расходомерами, воздухоотводчиком, краном впуск-выпуск, шаровым краном. Обратный коллектор с термостатическими клапанами и регулируемыми колпачками, воздухоотводчиком, краном впуск-выпуск, шаровым краном. Комплектуется с заглушками для коллектора и кронштейнами.

Cod./Code	(F) Misura/Size	(G) Attacco/Connection	Vie/Ways	L(mm)	H(mm)	□/田	€
1802A22502	1"	3/4" EK	2	263	200	1	
1802A22503	1"	3/4" EK	3	313	200	1	
1802A22504	1"	3/4" EK	4	363	200	1	
1802A22505	1"	3/4" EK	5	413	200	1	
1802A22506	1"	3/4" EK	6	463	200	1	
1802A22507	1"	3/4" EK	7	513	200	1	
1802A22508	1"	3/4" EK	8	563	200	1	
1802A22509	1"	3/4" EK	9	613	200	1	
1802A22510	1"	3/4" EK	10	663	200	1	
1802A22511	1"	3/4" EK	11	713	200	1	
1802A22512	1"	3/4" EK	12	763	200	1	
1802A32506	1"1/4	3/4" EK	6	486	200	1	
1802A32507	1"1/4	3/4" EK	7	536	200	1	
1802A32508	1"1/4	3/4" EK	8	586	200	1	
1802A32509	1"1/4	3/4" EK	9	636	200	1	
1802A32510	1"1/4	3/4" EK	10	686	200	1	
1802A32511	1"1/4	3/4" EK	11	736	200	1	
1802A32512	1"1/4	3/4" EK	12	786	200	1	

## KIT A 803 IVR

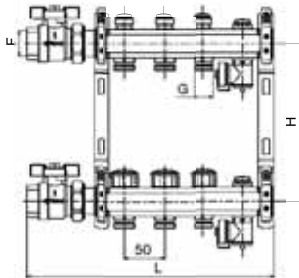

Collettore di mandata con detentori micrometrici, valvola sfogo aria, rubinetto di carico/scarico acqua, valvola a sfera. Collettore di ritorno con valvole termostattizzabili, cappellotti di regolazione, valvola sfogo aria, rubinetto di carico/scarico acqua e valvola a sfera, tappi inclusi, con zanche di fissaggio

Inlet manifold with micrometric lockshields, air vent and fill & drain valve, ball valve. Return manifold with thermostatic valves, operating plastic caps, air vent and fill & drain valve and ball valve, plugs included, with mounting brackets

Vorlaufverteiler mit mikrometrischen Rücklaufverschraubungen, Luftablassventil, Ein-/Ablussventil und Kugelhahn. Rücklaufverteiler mit thermostatisierbaren Ventilen, Einstellkappen, Luftablassventil, Ein-/Ablussventil und Kugelhahn - Stopfen inklusive, mit Befestigungsklammern

Collecteur d'alimentation avec détenteurs micrométriques, vanne de purge de l'air, robinet de chargement/déchargement, vanne à boisseau sphérique. Collecteur de retour avec vanne thermostatizable, chapeaux de réglage, vanne de purge de l'air, robinet de chargement/déchargement et vanne à boisseau sphérique, bouchons et plaques d'ancrage inclus

Входной коллектор с микрометрическими отсекающими вентилями, воздухоотводчиком, краном впуск-выпуск и шаровым краном. Обратный коллектор с термостатическими клапанами и регулируемыми колпачками, воздухоотводчиком, краном впуск-выпуск, шаровым краном и заглушками. В комплекте с кронштейнами.

Cod./Code	(F) Misura/Size	(G) Attacco/Connection	Vie/Ways	L(mm)	H(mm)	□/田	€
1803A22502	1"	3/4" EK	2	263	200	1	
1803A22503	1"	3/4" EK	3	313	200	1	
1803A22504	1"	3/4" EK	4	363	200	1	
1803A22505	1"	3/4" EK	5	413	200	1	
1803A22506	1"	3/4" EK	6	463	200	1	
1803A22507	1"	3/4" EK	7	513	200	1	
1803A22508	1"	3/4" EK	8	563	200	1	
1803A22509	1"	3/4" EK	9	613	200	1	
1803A22510	1"	3/4" EK	10	663	200	1	
1803A22511	1"	3/4" EK	11	713	200	1	
1803A22512	1"	3/4" EK	12	763	200	1	
1803A32506	1"1/4	3/4" EK	6	486	200	1	
1803A32507	1"1/4	3/4" EK	7	536	200	1	
1803A32508	1"1/4	3/4" EK	8	586	200	1	
1803A32509	1"1/4	3/4" EK	9	636	200	1	
1803A32510	1"1/4	3/4" EK	10	686	200	1	
1803A32511	1"1/4	3/4" EK	11	736	200	1	
1803A32512	1"1/4	3/4" EK	12	786	200	1	

## KIT A 814 IVR

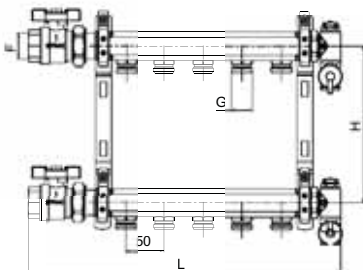

Collettore di mandata con valvola sfogo aria, rubinetto di carico/scarico acqua e valvola a sfera. Collettore di ritorno con valvola sfogo aria, rubinetto di carico/scarico acqua e valvola a sfera, tappi inclusi, con zanche di fissaggio

Inlet manifold with air vent, fill & drain valve and ball valve. Return manifold with air vent, fill & drain valve and ball valve, plugs included, with mounting brackets

Vorlaufverteiler mit Luftablassventil, Ein-/Ablussventil und Kugelhahn. Rücklaufverteiler mit Luftablassventil, Ein-/Ablussventil und Kugelhahn - Stopfen inklusive, mit Befestigungsklammern

Collecteur d'alimentation avec vanne de purge de l'air, robinet de chargement/déchargement et vanne à boisseau sphérique. Collecteur de retour avec vanne de purge de l'air, robinet de chargement/déchargement et vanne à boisseau sphérique, bouchons et plaques d'ancrage inclus

Входной коллектор с воздухоотводчиком, краном впуск-выпуск и шаровым краном. Обратный коллектор с воздухоотводчиком, краном впуск-выпуск, шаровым краном. Комплектуется с заглушками для коллектора и кронштейнами.

Cod./Code	(F) Misura/Size	(G) Attacco/Connection	Vie/Ways	L(mm)	H(mm)	□/田	€
1814A22502	1"	3/4" EK	2	248	200	1	
1814A22503	1"	3/4" EK	3	298	200	1	
1814A22504	1"	3/4" EK	4	348	200	1	
1814A22505	1"	3/4" EK	5	398	200	1	
1814A22506	1"	3/4" EK	6	448	200	1	
1814A22507	1"	3/4" EK	7	498	200	1	
1814A22508	1"	3/4" EK	8	548	200	1	
1814A22509	1"	3/4" EK	9	598	200	1	
1814A22510	1"	3/4" EK	10	648	200	1	
1814A22511	1"	3/4" EK	11	698	200	1	
1814A22512	1"	3/4" EK	12	748	200	1	
1814A32506	1"1/4	3/4" EK	6	798	200	1	
1814A32507	1"1/4	3/4" EK	7	848	200	1	
1814A32508	1"1/4	3/4" EK	8	898	200	1	
1814A32509	1"1/4	3/4" EK	9	948	200	1	
1814A32510	1"1/4	3/4" EK	10	998	200	1	
1814A32511	1"1/4	3/4" EK	11	1048	200	1	
1814A32512	1"1/4	3/4" EK	12	1098	200	1	

## IVR 800

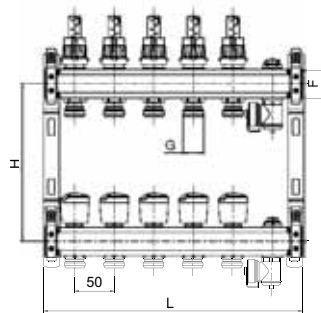

Collettore di mandata con misuratori di portata, valvola sfogo aria e rubinetto di carico/scarico acqua. Collettore di ritorno con valvole manuali con volantino, valvola sfogo aria e rubinetto di carico/scarico acqua, tappi e zanche di fissaggio incluse

Inlet manifold with flow meters, air vent and fill & drain valve. Return manifold with manual valves with handles, air vent and fill & drain valve, plugs and mounting brackets

Vorlaufverteiler mit Durchflussmessern, Entlüftungsventil und Füll - und Entleerungshahn. Rücklaufverteiler mit Ventilen mit Handrädern, Luftablassventil und Ein-/Ablassventil, komplett mit Kappen, mit Befestigungsklammern

Collecteur d'alimentation avec mesureurs de débits, vanne de purge de l'air et robinets de chargement/déchargement. Collecteur de retour avec vannes manuelles avec volant, vanne de purge de l'air et robinet de chargement/déchargement, bouchons et plaques d'ancrage inclus

Входной коллектор с расходомерами, воздухоотводчиком и краном выпуск-выпуск. Обратный коллектор с ручными регулирующими клапанами, воздухоотводчиком, краном выпуск-выпуск и заглушками. В комплекте с кронштейнами.

Cod./Code	(F) Misura/Size	(G) Attacco/Connection	Vie/Ways	L(mm)	H(mm)	□/田	€
180022502	1"	3/4" EK	2	180	200	1	
180022503	1"	3/4" EK	3	230	200	1	
180022504	1"	3/4" EK	4	280	200	1	
180022505	1"	3/4" EK	5	330	200	1	
180022506	1"	3/4" EK	6	380	200	1	
180022507	1"	3/4" EK	7	430	200	1	
180022508	1"	3/4" EK	8	480	200	1	
180022509	1"	3/4" EK	9	530	200	1	
180022510	1"	3/4" EK	10	580	200	1	
180022511	1"	3/4" EK	11	630	200	1	
180022512	1"	3/4" EK	12	680	200	1	
180032506	1"1/4	3/4" EK	6	380	200	1	
180032507	1"1/4	3/4" EK	7	430	200	1	
180032508	1"1/4	3/4" EK	8	480	200	1	
180032509	1"1/4	3/4" EK	9	530	200	1	
180032510	1"1/4	3/4" EK	10	580	200	1	
180032511	1"1/4	3/4" EK	11	630	200	1	
180032512	1"1/4	3/4" EK	12	680	200	1	

## IVR 801

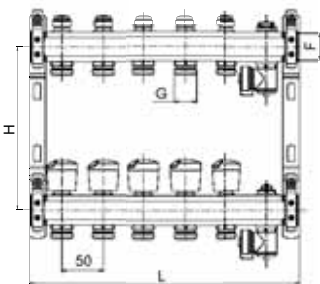

Collettore di mandata con detentori micrometrici, valvola sfogo aria e rubinetto di carico/scarico acqua. Collettore di ritorno con valvole manuali con volantino, valvola sfogo aria e rubinetto di carico/scarico acqua, tappi e zanche di fissaggio incluse

Inlet manifold with micrometric lockshields, air vent and fill & drain valve. Return manifold with manual valves with handles, air vent and fill & drain valve, plugs and mounting brackets

Vorlaufverteiler mit mikrometrischen Rücklaufverschraubungen, Luftablassventil und Ein-/Ablassventil. Rücklaufverteiler mit Ventilen mit Handrädern, Luftablassventil und Ein-/Ablassventil, komplett mit Kappen und Befestigungsklammern

Collecteur d'alimentation avec coude de réglage micrométriques, vanne de purge de l'air et robinet de chargement/déchargement. Collecteur de retour avec vannes manuelles avec volant, vanne de purge de l'air et robinet de chargement/déchargement, bouchons et plaques d'ancrage inclus

Входной коллектор с микрометрическими отсекающими вентилями, воздухоотводчиком и краном выпуск-выпуск. Обратный коллектор с ручными регулирующими клапанами, воздухоотводчиком, краном выпуск-выпуск и заглушками. В комплекте с кронштейнами.

Cod./Code	(F) Misura/Size	(G) Attacco/Connection	Vie/Ways	L(mm)	H(mm)	田/田	€
180122502	1"	3/4" EK	2	180	200	1	
180122503	1"	3/4" EK	3	230	200	1	
180122504	1"	3/4" EK	4	280	200	1	
180122505	1"	3/4" EK	5	330	200	1	
180122506	1"	3/4" EK	6	380	200	1	
180122507	1"	3/4" EK	7	430	200	1	
180122508	1"	3/4" EK	8	480	200	1	
180122509	1"	3/4" EK	9	530	200	1	
180122510	1"	3/4" EK	10	580	200	1	
180122511	1"	3/4" EK	11	630	200	1	
180122512	1"	3/4" EK	12	680	200	1	
180132506	1"1/4	3/4" EK	6	380	200	1	
180132507	1"1/4	3/4" EK	7	430	200	1	
180132508	1"1/4	3/4" EK	8	480	200	1	
180132509	1"1/4	3/4" EK	9	530	200	1	
180132510	1"1/4	3/4" EK	10	580	200	1	
180132511	1"1/4	3/4" EK	11	630	200	1	
180132512	1"1/4	3/4" EK	12	680	200	1	



## IVR 802

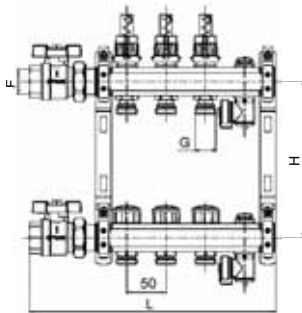

Collettore di mandata con misuratori di portata, valvola di sfogo aria e rubinetto di scarico/carico acqua. Collettore di ritorno con valvole termostattabili con cappellini di regolazione, valvola sfogo aria e rubinetto di carico/scarico, tappi e zanche di fissaggio incluse

Inlet manifold with flow meters, air vent and fill & drain valve. Return manifold with thermostatic valves with operating plastic caps, air vent and fill & drain valve, plugs and mounting brackets

Vorlaufverteiler mit Durchflussmessern, Luftablassventil und Ein-/Ablassventil. Rücklaufverteiler mit thermostatisierbaren Ventilen mit Einstellkappen, Luftablassventil und Ein-/Ablassventil, komplett mit Kappen und Befestigungsklammern

Collecteur d'alimentation avec mesureurs de débit, vanne de purge de l'air et robinet de chargement/déchargement. Collecteur de retour avec vannes thermostatissables avec chapeaux de réglage, vanne de purge de l'air et robinet de chargement/déchargement, bouchons et plaques d'ancrage inclus

Входной коллектор с расходомерами, воздухоотводчиком и краном впуск-выпуск. Обратный коллектор с термостатическими клапанами и регулируемыми колпачками, воздухоотводчиком, краном впуск-выпуск и заглушками. В комплекте с кронштейнами.

Cod./Code	(F) Misura/Size	(G) Attacco/Connection	Vie/Ways	L(mm)	H(mm)	□/田	€
180222502	1"	3/4" EK	2	180	200	1	
180222503	1"	3/4" EK	3	230	200	1	
180222504	1"	3/4" EK	4	280	200	1	
180222505	1"	3/4" EK	5	330	200	1	
180222506	1"	3/4" EK	6	380	200	1	
180222507	1"	3/4" EK	7	430	200	1	
180222508	1"	3/4" EK	8	480	200	1	
180222509	1"	3/4" EK	9	530	200	1	
180222510	1"	3/4" EK	10	580	200	1	
180222511	1"	3/4" EK	11	630	200	1	
180222512	1"	3/4" EK	12	680	200	1	
180232506	1"1/4	3/4" EK	6	380	200	1	
180232507	1"1/4	3/4" EK	7	430	200	1	
180232508	1"1/4	3/4" EK	8	480	200	1	
180232509	1"1/4	3/4" EK	9	530	200	1	
180232510	1"1/4	3/4" EK	10	580	200	1	
180232511	1"1/4	3/4" EK	11	630	200	1	
180232512	1"1/4	3/4" EK	12	680	200	1	

## IVR 803

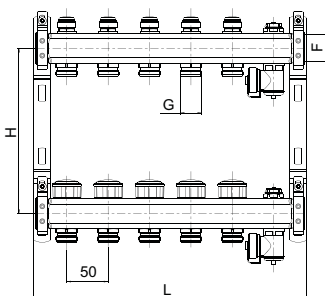

Collettore di mandata con detentori micrometrici, valvola sfogo aria e rubinetto di carico/scarico acqua. Collettore di ritorno con valvole termostattabili con cappellini di regolazione, valvola sfogo aria e rubinetto di carico/scarico acqua, tappi e zanche di fissaggio incluse

Inlet manifold with micrometric lockshields, air vent and fill & drain valve. Return manifold with thermostatic valves with operating plastic caps, air vent and fill & drain valve, plugs and mounting brackets included

Vorlaufverteiler mit mikrometrischen Rücklaufverschraubungen, Luftablassventil und Ein-/Ablassventil. Rücklaufverteiler mit thermostatisierbaren Ventilen mit Einstellkappen, Luftablassventil und Ein-/Ablassventil, komplett mit Kappen und Befestigungsklammern

Collecteur d'alimentation avec coude de réglage micrométriques, vanne de purge de l'air et robinet de chargement/déchargement. Collecteur de retour avec vannes thermostatissables avec chapeaux de réglage, vanne de purge de l'air et robinet de chargement/déchargement, caps enthalten, bouchons et plaques d'ancrage inclus

Входной коллектор с микрометрическими отсекающими вентилями, воздухоотводчиком и краном впуск-выпуск. Обратный коллектор с термостатическими клапанами и регулируемыми колпачками, воздухоотводчиком, краном впуск-выпуск и заглушками. В комплекте с кронштейнами.

Cod./Code	(F) Misura/Size	(G) Attacco/Connection	Vie/Ways	L(mm)	H(mm)	□/田	€
180322502	1"	3/4" EK	2	180	200	1	
180322503	1"	3/4" EK	3	230	200	1	
180322504	1"	3/4" EK	4	280	200	1	
180322505	1"	3/4" EK	5	330	200	1	
180322506	1"	3/4" EK	6	380	200	1	
180322507	1"	3/4" EK	7	430	200	1	
180322508	1"	3/4" EK	8	480	200	1	
180322509	1"	3/4" EK	9	530	200	1	
180322510	1"	3/4" EK	10	580	200	1	
180322511	1"	3/4" EK	11	630	200	1	
180322512	1"	3/4" EK	12	680	200	1	
180332506	1"1/4	3/4" EK	6	380	200	1	
180332507	1"1/4	3/4" EK	7	430	200	1	
180332508	1"1/4	3/4" EK	8	480	200	1	
180332509	1"1/4	3/4" EK	9	530	200	1	
180332510	1"1/4	3/4" EK	10	580	200	1	
180332511	1"1/4	3/4" EK	11	630	200	1	
180332512	1"1/4	3/4" EK	12	680	200	1	

## IVR 804

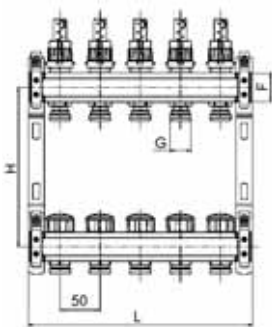

Collettore di mandata con misuratori di portata; collettore di ritorno con valvole termostattabili con cappellotti di regolazione, tappi e zanche di fissaggio incluse

Inlet manifold with flow meters; return manifold with thermostatic valves with operating plastic caps, plugs and mounting brackets included

Vorlaufverteiler mit Durchflussmessern; Rücklaufverteiler mit thermostatisierbaren Ventilen mit Einstellkappen, komplett mit Kappen und Befestigungsklammern

Collecteur d'alimentation avec mesureurs de débit; collecteur de retour avec vannes thermostatissables avec chapeaux de réglage, bouchons et plaques d'ancrage inclus

Входной коллектор с расходомерами; Обратный коллектор с термостатическими клапанами и регулируемыми колпачками. Комплектуется с заглушками для коллектора и кронштейнами.

Cod./Code	(F) Misura/Size	(G) Attacco/Connection	Vie/Ways	L(mm)	H(mm)	□/田	€
180422502	1"	3/4" EK	2	130	200	1	
180422503	1"	3/4" EK	3	180	200	1	
180422504	1"	3/4" EK	4	230	200	1	
180422505	1"	3/4" EK	5	280	200	1	
180422506	1"	3/4" EK	6	330	200	1	
180422507	1"	3/4" EK	7	380	200	1	
180422508	1"	3/4" EK	8	430	200	1	
180422509	1"	3/4" EK	9	480	200	1	
180422510	1"	3/4" EK	10	530	200	1	
180422511	1"	3/4" EK	11	580	200	1	
180422512	1"	3/4" EK	12	630	200	1	
180422513	1"	3/4" EK	13	680	200	1	
<hr/>							
180432506	1"1/4	3/4" EK	6	330	200	1	
180432507	1"1/4	3/4" EK	7	380	200	1	
180432508	1"1/4	3/4" EK	8	430	200	1	
180432509	1"1/4	3/4" EK	9	480	200	1	
180432510	1"1/4	3/4" EK	10	530	200	1	
180432511	1"1/4	3/4" EK	11	580	200	1	
180432512	1"1/4	3/4" EK	12	630	200	1	
180432513	1"1/4	3/4" EK	13	680	200	1	

## IVR 804/R

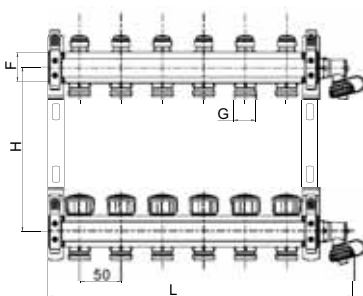

Collettore di mandata con misuratori di portata e rubinetto di carico/scarico acqua; collettore di ritorno con valvola termostattabili con cappello di regolazione e rubinetto di carico/scarico acqua, tappi e zanche di fissaggio incluse

Inlet manifold with flow meters and fill & drain valve; outlet manifold with thermostatic valves with operating plastic cap and fill & drain valve, plugs and mounting brackets included

Vorlaufverteiler mit Durchflussmeter und ein-/Ablassventil; Rücklaufverteiler mit thermostatisierbaren Ventilen mit Einstellkappe und Ein-/Ablassventil, komplett mit Kappen und Befestigungsklammern

Collecteur d'alimentation avec mesureur de débit et robinet de chargement/déchargement; collecteur de retour avec vannes thermostatissables avec chapeau de réglage e robinet de chargement/déchargement, bouchons et plaques d'ancrage inclus

Входной коллектор с расходомерами и краном впуск-выпуск; Обратный коллектор с термостатическими клапанами и регулируемыми колпачками, кран впуск-выпуск

Cod./Code	(F) Misura/Size	(G) Attacco/Connection	Vie/Ways	L(mm)	H(mm)	□/田	€
1804R22502	1"	3/4" EK	2	171	200	1	
1804R22503	1"	3/4" EK	3	221	200	1	
1804R22504	1"	3/4" EK	4	271	200	1	
1804R22505	1"	3/4" EK	5	321	200	1	
1804R22506	1"	3/4" EK	6	371	200	1	
1804R22507	1"	3/4" EK	7	421	200	1	
1804R22508	1"	3/4" EK	8	471	200	1	
1804R22509	1"	3/4" EK	9	521	200	1	
1804R22510	1"	3/4" EK	10	571	200	1	
1804R22511	1"	3/4" EK	11	621	200	1	
1804R22512	1"	3/4" EK	12	671	200	1	
1804R22513	1"	3/4" EK	13	721	200	1	

## IVR 805

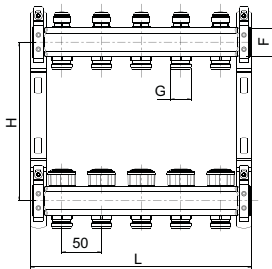

Collettore di mandata con detentori micrometrici; collettore di ritorno con valvole termostattizzabili con cappellotti di regolazione, tappi e zanche di fissaggio incluse

Inlet manifold with micrometric lockshields; return manifold with thermostatic valves with operating plastic caps, plugs and mounting brackets included

Vorlaufverteiler mit mikrometrischen Rücklaufverschraubungen; Rücklaufverteiler mit thermostatisierbaren Ventilen mit Einstellkappen, komplett mit Kappen und Befestigungsklammern

Collecteur d'alimentation avec coude de réglage micrométriques; collecteur de retour avec vannes thermostatisables avec chapeaux de réglage, bouchons et plaques d'ancrage inclus

Входной коллектор с микрометрическими отсекающими вентилями. Обратный коллектор с термостатическими клапанами и регулируемыми колпачками. Комплектуется с заглушками для коллектора и кронштейнами.

Cod./Code	(F) Misura/Size	(G) Attacco/Connection	Vie/Ways	L(mm)	H(mm)	□/田	€
180522502	1"	3/4" EK	2	130	200	1	
180522503	1"	3/4" EK	3	180	200	1	
180522504	1"	3/4" EK	4	230	200	1	
180522505	1"	3/4" EK	5	280	200	1	
180522506	1"	3/4" EK	6	330	200	1	
180522507	1"	3/4" EK	7	380	200	1	
180522508	1"	3/4" EK	8	430	200	1	
180522509	1"	3/4" EK	9	480	200	1	
180522510	1"	3/4" EK	10	530	200	1	
180522511	1"	3/4" EK	11	580	200	1	
180522512	1"	3/4" EK	12	630	200	1	
180522513	1"	3/4" EK	13	680	200	1	
180532506	1"1/4	3/4" EK	6	330	200	1	
180532507	1"1/4	3/4" EK	7	380	200	1	
180532508	1"1/4	3/4" EK	8	430	200	1	
180532509	1"1/4	3/4" EK	9	480	200	1	
180532510	1"1/4	3/4" EK	10	530	200	1	
180532511	1"1/4	3/4" EK	11	580	200	1	
180532512	1"1/4	3/4" EK	12	630	200	1	
180532513	1"1/4	3/4" EK	13	680	200	1	

## IVR 805/R

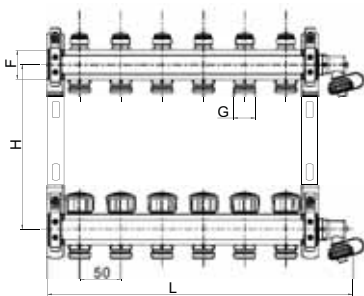

Collettore di mandata con detentori micrometrici e rubinetto di carico/scarico acqua; collettore di ritorno con valvole termostattizzabili con cappellotto di regolazione e rubinetto di carico/scarico acqua, tappi e zanche di fissaggio incluse

Inlet manifold with micrometric lockshields and fill & drain valve; outlet manifold with thermostatic valves with operating plastic cap and fill & drain valve, plugs and mounting brackets included

Vorlaufverteiler mit mikrometrischen Rücklaufverschraubungen und Ein-/Ablassventil; Rücklaufverteiler mit thermostatisierbaren Ventilen mit Einstellkappe und Ein-/Ablassventil, komplett mit Kappen und Befestigungsklammern

Collecteur d'alimentation avec coude de réglage micrométrique et robinet de chargement/déchargement; collecteur de retour avec vannes thermostatisables avec chapeau de réglage et robinet de chargement/déchargement, bouchons et plaques d'ancrage inclus

Входной коллектор с микрометрическими отсекающими вентилями и краном впуск-выпуск; Обратный коллектор с термостатическими клапанами и регулирующим колпачком, кран впуск-выпуск. Комплектуется с заглушками для коллектора и кронштейнами.

Cod./Code	(F) Misura/Size	(G) Attacco/Connection	Vie/Ways	L(mm)	H(mm)	□/田	€
1805R22502	1"	3/4" EK	2	171	200	1	
1805R22503	1"	3/4" EK	3	221	200	1	
1805R22504	1"	3/4" EK	4	271	200	1	
1805R22505	1"	3/4" EK	5	321	200	1	
1805R22506	1"	3/4" EK	6	371	200	1	
1805R22507	1"	3/4" EK	7	421	200	1	
1805R22508	1"	3/4" EK	8	471	200	1	
1805R22509	1"	3/4" EK	9	521	200	1	
1805R22510	1"	3/4" EK	10	571	200	1	
1805R22511	1"	3/4" EK	11	621	200	1	
1805R22512	1"	3/4" EK	12	671	200	1	
1805R22513	1"	3/4" EK	13	721	200	1	



## IVR 806

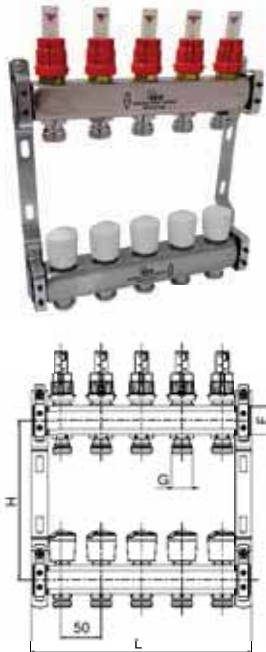

Collettore di mandata con misuratori di portata. Collettore di ritorno con valvole manuali con volantini, tappi e zanche di fissaggio incluse

Inlet manifold with flow meters. Return manifold with manual valves with handles, plugs and mounting brackets included

Vorlaufverteiler mit Durchflussmessern. Rücklaufverteiler mit Ventilen mit Handrädern, komplett mit Kappen und Befestigungsklammern

Collecteur d'alimentation avec mesureurs de débit. Collecteur de retour avec vannes manuelles avec volantins, bouchons et plaques d'ancrage inclus

Входной коллектор с расходомерами. Обратный коллектор с ручными регулируемыми клапанами и заглушками. В комплекте с кронштейнами.

Cod./Code	(F) Misura/Size	(G) Attacco/Connection	Vie/Ways	L(mm)	H(mm)	□/田	€
180622502	1"	3/4" EK	2	130	200	1	
180622503	1"	3/4" EK	3	180	200	1	
180622504	1"	3/4" EK	4	230	200	1	
180622505	1"	3/4" EK	5	280	200	1	
180622506	1"	3/4" EK	6	330	200	1	
180622507	1"	3/4" EK	7	380	200	1	
180622508	1"	3/4" EK	8	430	200	1	
180622509	1"	3/4" EK	9	480	200	1	
180622510	1"	3/4" EK	10	530	200	1	
180622511	1"	3/4" EK	11	580	200	1	
180622512	1"	3/4" EK	12	630	200	1	
180622513	1"	3/4" EK	13	680	200	1	
180632506	1"1/4	3/4" EK	6	330	200	1	
180632507	1"1/4	3/4" EK	7	380	200	1	
180632508	1"1/4	3/4" EK	8	430	200	1	
180632509	1"1/4	3/4" EK	9	480	200	1	
180632510	1"1/4	3/4" EK	10	530	200	1	
180632511	1"1/4	3/4" EK	11	580	200	1	
180632512	1"1/4	3/4" EK	12	630	200	1	
180632513	1"1/4	3/4" EK	13	680	200	1	

## IVR 807

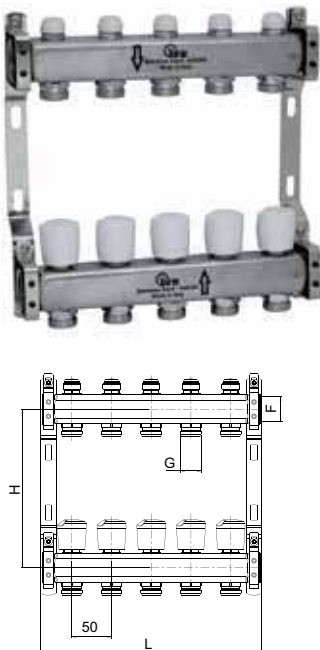

Collettore di mandata con detentori micrometrici. Collettore di ritorno con valvole manuali con volantini, tappi e zanche di fissaggio incluse

Inlet manifold with micrometric lockshields. Return manifold with manual valves with handles, plugs and mounting brackets included

Vorlaufverteiler mit mikrometrischen Rücklaufverschraubungen. Rücklaufverteiler mit Ventilen mit Handrädern, komplett mit Kappen und Befestigungsklammern

Collecteur d'alimentation avec coupe de réglage micrométriques. Collecteur de retour avec vannes manuelles avec volantins, bouchons et plaques d'ancrage inclus

Входной коллектор с микрометрическими отсекающими вентилями. Обратный коллектор с ручными регулируемыми клапанами и заглушками. В комплекте с кронштейнами.

Cod./Code	(F) Misura/Size	(G) Attacco/Connection	Vie/Ways	L(mm)	H(mm)	□/田	€
180722502	1"	3/4" EK	2	130	200	1	
180722503	1"	3/4" EK	3	180	200	1	
180722504	1"	3/4" EK	4	230	200	1	
180722505	1"	3/4" EK	5	280	200	1	
180722506	1"	3/4" EK	6	330	200	1	
180722507	1"	3/4" EK	7	380	200	1	
180722508	1"	3/4" EK	8	430	200	1	
180722509	1"	3/4" EK	9	480	200	1	
180722510	1"	3/4" EK	10	530	200	1	
180722511	1"	3/4" EK	11	580	200	1	
180722512	1"	3/4" EK	12	630	200	1	
180722513	1"	3/4" EK	13	680	200	1	
180732506	1"1/4	3/4" EK	6	330	200	1	
180732507	1"1/4	3/4" EK	7	380	200	1	
180732508	1"1/4	3/4" EK	8	430	200	1	
180732509	1"1/4	3/4" EK	9	480	200	1	
180732510	1"1/4	3/4" EK	10	530	200	1	
180732511	1"1/4	3/4" EK	11	580	200	1	
180732512	1"1/4	3/4" EK	12	630	200	1	
180732513	1"1/4	3/4" EK	13	680	200	1	

## IVR 813

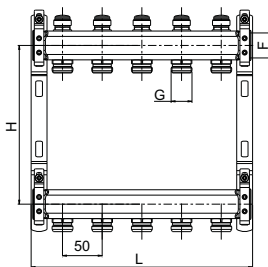

Collettore di mandata con detentori micrometrici. Collettore di ritorno con raccordi 3/4" Eurokonus, tappi e zanche di fissaggio incluse

Inlet manifold with micrometric lockshields. Return manifold with 3/4" Eurocone connections, plugs and mounting brackets included

Vorlaufverteiler mit mikrometrischen Rücklaufverschraubungen. Rücklaufverteiler mit 3/4" EK Verbindungsstücken, komplett mit Kappen und Befestigungsklammern

Collecteur d'alimentation avec coude de réglage micrométriques. Collecteur de retour avec sorties 3/4" EK, bouchons et plaques d'ancrage inclus

Входной коллектор с микрометрическими отсекающими вентилями. Обратный коллектор. Комплектуется с заглушками для коллектора и кронштейнами.

Cod./Code	(F) Misura/Size	(G) Attacco/Connection	Vie/Ways	L(mm)	H(mm)	□/田	€
181322502	1"	3/4" EK	2	130	200	1	
181322503	1"	3/4" EK	3	180	200	1	
181322504	1"	3/4" EK	4	230	200	1	
181322505	1"	3/4" EK	5	280	200	1	
181322506	1"	3/4" EK	6	330	200	1	
181322507	1"	3/4" EK	7	380	200	1	
181322508	1"	3/4" EK	8	430	200	1	
181322509	1"	3/4" EK	9	480	200	1	
181322510	1"	3/4" EK	10	530	200	1	
181322511	1"	3/4" EK	11	580	200	1	
181322512	1"	3/4" EK	12	630	200	1	
181322513	1"	3/4" EK	13	680	200	1	
181332506	1"1/4	3/4" EK	6	330	200	1	
181332507	1"1/4	3/4" EK	7	380	200	1	
181332508	1"1/4	3/4" EK	8	430	200	1	
181332509	1"1/4	3/4" EK	9	480	200	1	
181332510	1"1/4	3/4" EK	10	530	200	1	
181332511	1"1/4	3/4" EK	11	580	200	1	
181332512	1"1/4	3/4" EK	12	630	200	1	
181332513	1"1/4	3/4" EK	13	680	200	1	

## IVR 814

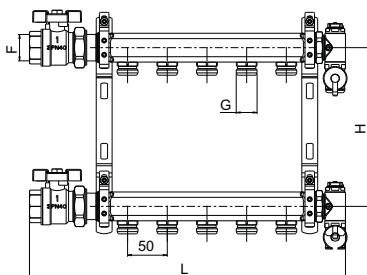

Collettore di mandata con collettore di ritorno con raccordi 3/4" Eurokonus, tappi e zanche di fissaggio incluse

Inlet manifold with return manifold with 3/4" Eurocone connections, plugs and mounting brackets included

Vorlaufverteiler mit Rücklaufverteiler mit 3/4" EK Verbindungsstücken, komplett mit Kappen und Befestigungsklammern

Collecteur d'alimentation avec collecteur de retour avec sorties 3/4" EK, bouchons et plaques d'ancrage inclus

Входной коллектор с обратным коллектором. Комплектуется с заглушками для коллектора и кронштейнами.

Cod./Code	(F) Misura/Size	(G) Attacco/Connection	Vie/Ways	L(mm)	H(mm)	□/田	€
181422502	1"	3/4" EK	2	130	200	1	
181422503	1"	3/4" EK	3	180	200	1	
181422504	1"	3/4" EK	4	230	200	1	
181422505	1"	3/4" EK	5	280	200	1	
181422506	1"	3/4" EK	6	330	200	1	
181422507	1"	3/4" EK	7	380	200	1	
181422508	1"	3/4" EK	8	430	200	1	
181422509	1"	3/4" EK	9	480	200	1	
181422510	1"	3/4" EK	10	530	200	1	
181422511	1"	3/4" EK	11	580	200	1	
181422512	1"	3/4" EK	12	630	200	1	
181422513	1"	3/4" EK	13	680	200	1	
181432506	1"1/4	3/4" EK	6	330	200	1	
181432507	1"1/4	3/4" EK	7	380	200	1	
181432508	1"1/4	3/4" EK	8	430	200	1	
181432509	1"1/4	3/4" EK	9	480	200	1	
181432510	1"1/4	3/4" EK	10	530	200	1	
181432511	1"1/4	3/4" EK	11	580	200	1	
181432512	1"1/4	3/4" EK	12	630	200	1	
181432513	1"1/4	3/4" EK	13	680	200	1	

## COLLETTORI / MANIFOLDS

Collettori Inox / Inox Manifolds  
AVANT FLOOR COMPONENTS



Collettore in acciaio inox AISI 304 1" - 1"1/4; Connessioni 3/4" EK - Interasse: 50 mm  
 AISI 304 stainless steel manifold 1" - 1"1/4; 3/4" Eurocone connections - Center hole distance 50 mm  
 Verteiler aus rostfreiem Edelstahl AISI 304 1" - 1"1/4; 3/4" Anschlüsse Eurokonus - Abstand 50 mm  
 Collecteur en acier inox AISI 304 1" - 1"1/4; connexion 3/4" eurocone - entraxes 50mm  
 Коллектор из нержавеющей стали AISI 304, размеры 1" - 1"1/4; 3/4", соединение Евроконус, межосевое расстояние 50 мм

### IVR 875 CS



Collettore di ritorno con valvole termostattizzabili e cappellotti di regolazione, valvola sfogo aria e rubinetto di carico/scarico acqua

Return manifold with thermostatic valves and operating plastic caps, air vent and fill & drain valve

Rücklaufverteiler mit thermostatisierbaren Ventilen und Handrädern, Luftablassventil und Ein-/Ablassventil

Collecteur de retour avec vannes thermostatissables et chapeaux de réglage, vanne de purge d'air et robinet de chargement/déchargement

Обратный коллектор с термостатическими клапанами и регулируемыми колпачками, воздухоотводчиком и дренажным клапаном.

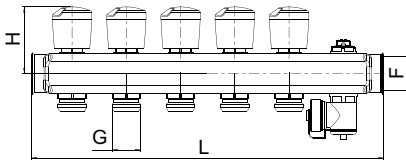

Cod./Code	(F) Misura/Size	(G) Attacco/Connection	Vie/Ways	L(mm)	H(mm)	□/田	€
187510502	1"	3/4" EK	2	175	61	1	
187510503	1"	3/4" EK	3	225	61	1	
187510504	1"	3/4" EK	4	275	61	1	
187510505	1"	3/4" EK	5	325	61	1	
187510506	1"	3/4" EK	6	375	61	1	
187510507	1"	3/4" EK	7	425	61	1	
187510508	1"	3/4" EK	8	475	61	1	
187510509	1"	3/4" EK	9	525	61	1	
187510510	1"	3/4" EK	10	575	61	1	
187510511	1"	3/4" EK	11	625	61	1	
187510512	1"	3/4" EK	12	675	61	1	
187512506	1"1/4	3/4" EK	6	375	66	1	
187512507	1"1/4	3/4" EK	7	425	66	1	
187512508	1"1/4	3/4" EK	8	475	66	1	
187512509	1"1/4	3/4" EK	9	525	66	1	
187512510	1"1/4	3/4" EK	10	575	66	1	
187512511	1"1/4	3/4" EK	11	625	66	1	
187512512	1"1/4	3/4" EK	12	675	66	1	

### IVR 875



Collettore di ritorno con valvole manuali e volantini manuali

Return manifold with manual valves and manual handles

Rücklaufverteiler mit Regulierventil und Handrädern

Collecteur de retour avec vannes manuelles

Обратный коллектор с ручными регулируемыми клапанами

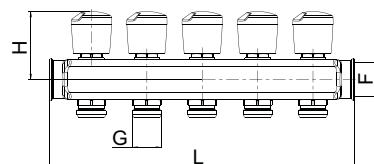

Cod./Code	(F) Misura/Size	(G) Attacco/Connection	Vie/Ways	L(mm)	H(mm)	□/田	€
187511502	1"	3/4" EK	2	125	61	1	
187511503	1"	3/4" EK	3	175	61	1	
187511504	1"	3/4" EK	4	225	61	1	
187511505	1"	3/4" EK	5	275	61	1	
187511506	1"	3/4" EK	6	325	61	1	
187511507	1"	3/4" EK	7	375	61	1	
187511508	1"	3/4" EK	8	425	61	1	
187511509	1"	3/4" EK	9	475	61	1	
187511510	1"	3/4" EK	10	525	61	1	
187511511	1"	3/4" EK	11	575	61	1	
187511512	1"	3/4" EK	12	625	61	1	
187511513	1"	3/4" EK	13	675	61	1	
187513506	1"1/4	3/4" EK	6	325	66	1	
187513507	1"1/4	3/4" EK	7	375	66	1	
187513508	1"1/4	3/4" EK	8	425	66	1	
187513509	1"1/4	3/4" EK	9	475	66	1	
187513510	1"1/4	3/4" EK	10	525	66	1	
187513511	1"1/4	3/4" EK	11	575	66	1	
187513512	1"1/4	3/4" EK	12	625	66	1	
187513513	1"1/4	3/4" EK	13	675	66	1	

## IVR 877 CS

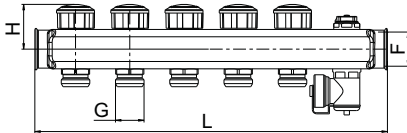

Collettore di ritorno con valvole termostattizzabili e cappellotti di regolazione, valvola sfogo aria e rubinetto di carico/scarico acqua

Return manifold with thermostatic valves and operating plastic caps, air vent and fill & drain valve

Rücklaufverteiler mit thermostatisierbaren Ventilen und Handrädern, Luftablassventil und Ein-/Ablassventil

Collecteur de retour avec vannes thermostatissables et chapeaux de réglage, vanne de purge d'air et robinet de chargement/déchargement

Обратный коллектор с термостатическими клапанами и регулируемыми колпачками, воздухоотводчиком и дренажным клапаном.

Cod./Code	(F) Misura/Size	(G) Attacco/Connection	Vie/Ways	L(mm)	H(mm)	□/田	€
187710502	1"	3/4" EK	2	175	41	1	
187710503	1"	3/4" EK	3	225	41	1	
187710504	1"	3/4" EK	4	275	41	1	
187710505	1"	3/4" EK	5	325	41	1	
187710506	1"	3/4" EK	6	375	41	1	
187710507	1"	3/4" EK	7	425	41	1	
187710508	1"	3/4" EK	8	475	41	1	
187710509	1"	3/4" EK	9	525	41	1	
187710510	1"	3/4" EK	10	575	41	1	
187710511	1"	3/4" EK	11	625	41	1	
187710512	1"	3/4" EK	12	675	41	1	
187712506	1"1/4	3/4" EK	6	375	46	1	
187712507	1"1/4	3/4" EK	7	425	46	1	
187712508	1"1/4	3/4" EK	8	475	46	1	
187712509	1"1/4	3/4" EK	9	525	46	1	
187712510	1"1/4	3/4" EK	10	575	46	1	
187712511	1"1/4	3/4" EK	11	625	46	1	
187712512	1"1/4	3/4" EK	12	675	46	1	

## IVR 877

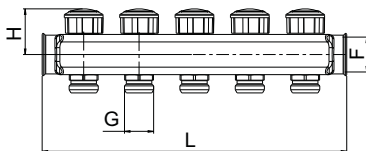

Collettore di ritorno con valvole termostattizzabili e cappellotti di regolazione

Return manifold with thermostatic valves and operating manual caps

Rücklaufverteiler mit Regulierventilen (für thermoelektrischen Kopf) und Handrädern

Collecteur de retour avec vannes thermostatissables, et chapeaux de réglage

Обратный коллектор с термостатическими клапанами и регулируемыми колпачками

Cod./Code	(F) Misura/Size	(G) Attacco/Connection	Vie/Ways	L(mm)	H(mm)	□/田	€
187711502	1"	3/4" EK	2	125	41	1	
187711503	1"	3/4" EK	3	175	41	1	
187711504	1"	3/4" EK	4	225	41	1	
187711505	1"	3/4" EK	5	275	41	1	
187711506	1"	3/4" EK	6	325	41	1	
187711507	1"	3/4" EK	7	375	41	1	
187711508	1"	3/4" EK	8	425	41	1	
187711509	1"	3/4" EK	9	475	41	1	
187711510	1"	3/4" EK	10	525	41	1	
187711511	1"	3/4" EK	11	575	41	1	
187711512	1"	3/4" EK	12	625	41	1	
187711513	1"	3/4" EK	13	675	41	1	
187713506	1"1/4	3/4" EK	6	325	46	1	
187713507	1"1/4	3/4" EK	7	375	46	1	
187713508	1"1/4	3/4" EK	8	425	46	1	
187713509	1"1/4	3/4" EK	9	475	46	1	
187713510	1"1/4	3/4" EK	10	525	46	1	
187713511	1"1/4	3/4" EK	11	575	46	1	
187713512	1"1/4	3/4" EK	12	625	46	1	
187713513	1"1/4	3/4" EK	13	675	46	1	

## IVR 877/R

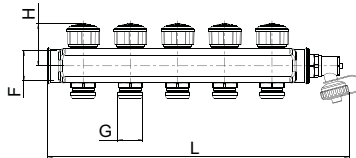

Collettore di ritorno con valvole termostattizzabili con cappello di regolazione e con rubinetto di carico/scarico acqua

Outlet manifold with thermostatic valves with operating plastic cap and fill & drain valve

Rücklaufverteiler mit thermostatisierbaren Ventilen mit Einstellkappe und Ein-/Ablassventil

Collecteur de retour avec vannes thermostatissables avec chapeau de réglage et avec robinet de chargement/déchargement

Обратный коллектор с термостатическими клапанами, регулирующим колпачком и дренажным клапаном.

Cod./Code	(F) Misura/Size	(G) Attacco/Connection	Vie/Ways	L(mm)	H(mm)	□/田	€
1877R10502	1"	3/4" EK	2	169	41	1	
1877R10503	1"	3/4" EK	3	219	41	1	
1877R10504	1"	3/4" EK	4	269	41	1	
1877R10505	1"	3/4" EK	5	319	41	1	
1877R10506	1"	3/4" EK	6	369	41	1	
1877R10507	1"	3/4" EK	7	419	41	1	
1877R10508	1"	3/4" EK	8	469	41	1	
1877R10509	1"	3/4" EK	9	519	41	1	
1877R10510	1"	3/4" EK	10	569	41	1	
1877R10511	1"	3/4" EK	11	619	41	1	
1877R10512	1"	3/4" EK	12	669	41	1	
1877R10513	1"	3/4" EK	13	709	41	1	

## IVR 878 CS

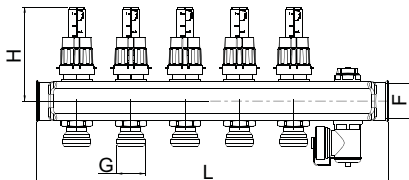

Collettore di mandata con misuratori di portata 0,5-5 lt/min. valvola sfogo aria, rubinetto di carico/scarico acqua

Inlet manifold with flow meters 0,5-5 L/min, air vent and fill & drain valve

Vorlaufverteiler mit Durchflussmessern 0,5-5 lt/min. Luftablassventil und Ein-/Ablassventil

Collecteur d'alimentation avec débitmètres 0,5-5 lt/min., vanne de purge de l'air et robinet de chargement/déchargement

Входной коллектор с расходомерами 0,5-5 л/мин, воздухоотводчиком и дренажным клапаном

Cod./Code	(F) Misura/Size	(G) Attacco/Connection	Vie/Ways	L(mm)	H(mm)	□/田	€
187810502	1"	3/4" EK	2	175	93	1	
187810503	1"	3/4" EK	3	225	93	1	
187810504	1"	3/4" EK	4	275	93	1	
187810505	1"	3/4" EK	5	325	93	1	
187810506	1"	3/4" EK	6	375	93	1	
187810507	1"	3/4" EK	7	425	93	1	
187810508	1"	3/4" EK	8	475	93	1	
187810509	1"	3/4" EK	9	525	93	1	
187810510	1"	3/4" EK	10	575	93	1	
187810511	1"	3/4" EK	11	625	93	1	
187810512	1"	3/4" EK	12	675	93	1	
187812506	1"1/4	3/4" EK	6	375	98	1	
187812507	1"1/4	3/4" EK	7	425	98	1	
187812508	1"1/4	3/4" EK	8	475	98	1	
187812509	1"1/4	3/4" EK	9	525	98	1	
187812510	1"1/4	3/4" EK	10	575	98	1	
187812511	1"1/4	3/4" EK	11	625	98	1	
187812512	1"1/4	3/4" EK	12	675	98	1	



## IVR 878



Collettore di mandata con misuratori di portata 0,5-5 lt/min.

Inlet manifold with flow meters 0,5-5 L/min

Vorlaufverteiler mit Durchflussmessern 0,5-5 lt/min

Collecteur d'alimentation avec débitmètres 0,5-5 lt/min

Входной коллектор с расходомерами 0,5-5 л/мин

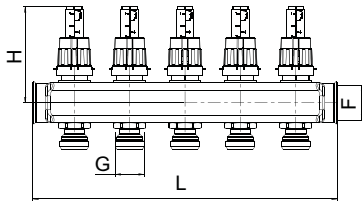

Cod./Code	(F) Misura/Size	(G) Attacco/Connection	Vie/Ways	L(mm)	H(mm)	□/田	€
187811502	1"	3/4" EK	2	125	93	1	
187811503	1"	3/4" EK	3	175	93	1	
187811504	1"	3/4" EK	4	225	93	1	
187811505	1"	3/4" EK	5	275	93	1	
187811506	1"	3/4" EK	6	325	93	1	
187811507	1"	3/4" EK	7	375	93	1	
187811508	1"	3/4" EK	8	425	93	1	
187811509	1"	3/4" EK	9	475	93	1	
187811510	1"	3/4" EK	10	525	93	1	
187811511	1"	3/4" EK	11	575	93	1	
187811512	1"	3/4" EK	12	625	93	1	
187811513	1"	3/4" EK	13	675	93	1	
187813506	1"1/4	3/4" EK	6	325	98	1	
187813507	1"1/4	3/4" EK	7	375	98	1	
187813508	1"1/4	3/4" EK	8	425	98	1	
187813509	1"1/4	3/4" EK	9	475	98	1	
187813510	1"1/4	3/4" EK	10	525	98	1	
187813511	1"1/4	3/4" EK	11	575	98	1	
187813512	1"1/4	3/4" EK	12	625	98	1	
187813513	1"1/4	3/4" EK	13	675	98	1	

## IVR 878/R



Collettore di mandata con misuratori i portata 0,5-5 lt/min e con rubinetto di carico/scarico acqua

Inlet manifold with flow meters 0.5-5 L/min and fill & drain valve

Vorlaufverteiler mit Durchflussmesser 0,5-5 lt/Min. und Ein-/Ablassventil

Collecteur d'alimentation avec mesureur de débit 0,5-5 lt/min et avec robinet de chargement/déchargement

Входной коллектор с расходомерами 0,5-5 л/мин и дренажным клапаном

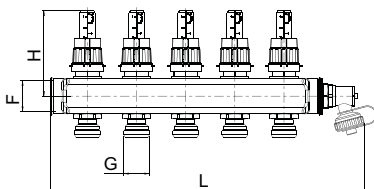

Cod./Code	(F) Misura/Size	(G) Attacco/Connection	Vie/Ways	L(mm)	H(mm)	□/田	€
1878R11502	1"	3/4" EK	2	169	93	1	
1878R11503	1"	3/4" EK	3	219	93	1	
1878R11504	1"	3/4" EK	4	269	93	1	
1878R11505	1"	3/4" EK	5	319	93	1	
1878R11506	1"	3/4" EK	6	369	93	1	
1878R11507	1"	3/4" EK	7	419	93	1	
1878R11508	1"	3/4" EK	8	469	93	1	
1878R11509	1"	3/4" EK	9	519	93	1	
1878R11510	1"	3/4" EK	10	569	93	1	
1878R11511	1"	3/4" EK	11	619	93	1	
1878R11512	1"	3/4" EK	12	669	93	1	
1878R11513	1"	3/4" EK	13	719	93	1	

## IVR 879 CS



Collettore di mandata con detentori micrometrici, valvola sfogo aria, rubinetto di carico/scarico acqua  
Inlet manifold with micrometric lockshields, air vent, fill & drain valve

Vorlaufverteiler mit mikrometrischen Rücklaufverschraubungen und Ein-/Ablassventil

Collecteur d'alimentation avec coudes de réglage micrométriques, vanne de purge de l'air, robinet de chargement/déchargement

Входной коллектор с микрометрическими отсекающими клапанами, воздухоотводчиком и дренажным клапаном

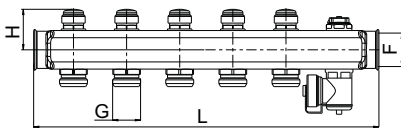

Cod./Code	(F) Misura/Size	(G) Attacco/Connection	Vie/Ways	L(mm)	H(mm)	□/田	€
187910502	1"	3/4" EK	2	175	38	1	
187910503	1"	3/4" EK	3	225	38	1	
187910504	1"	3/4" EK	4	275	38	1	
187910505	1"	3/4" EK	5	325	38	1	
187910506	1"	3/4" EK	6	375	38	1	
187910507	1"	3/4" EK	7	425	38	1	
187910508	1"	3/4" EK	8	475	38	1	
187910509	1"	3/4" EK	9	525	38	1	
187910510	1"	3/4" EK	10	575	38	1	
187910511	1"	3/4" EK	11	625	38	1	
187910512	1"	3/4" EK	12	675	38	1	
187912506	1"1/4	3/4" EK	6	375	43	1	
187912507	1"1/4	3/4" EK	7	425	43	1	
187912508	1"1/4	3/4" EK	8	475	43	1	
187912509	1"1/4	3/4" EK	9	525	43	1	
187912510	1"1/4	3/4" EK	10	575	43	1	
187912511	1"1/4	3/4" EK	11	625	43	1	
187912512	1"1/4	3/4" EK	12	675	43	1	

## IVR 879



Collettore di mandata con detentori micrometrici

Inlet manifold with micrometric lockshields

Vorlaufverteiler mit mikrometrischen Rücklaufverschraubungen

Collecteur d'alimentation avec coudes de réglage micrométriques

Входной коллектор с микрометрическими отсекающими клапанами

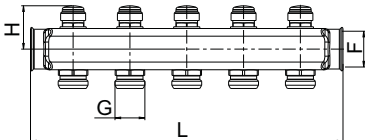

Cod./Code	(F) Misura/Size	(G) Attacco/Connection	Vie/Ways	L(mm)	H(mm)	□/田	€
187911502	1"	3/4" EK	2	125	38	1	
187911503	1"	3/4" EK	3	175	38	1	
187911504	1"	3/4" EK	4	225	38	1	
187911505	1"	3/4" EK	5	275	38	1	
187911506	1"	3/4" EK	6	325	38	1	
187911507	1"	3/4" EK	7	375	38	1	
187911508	1"	3/4" EK	8	425	38	1	
187911509	1"	3/4" EK	9	475	38	1	
187911510	1"	3/4" EK	10	525	38	1	
187911511	1"	3/4" EK	11	575	38	1	
187911512	1"	3/4" EK	12	625	38	1	
187911513	1"	3/4" EK	13	675	38	1	
187913506	1"1/4	3/4" EK	6	325	43	1	
187913507	1"1/4	3/4" EK	7	375	43	1	
187913508	1"1/4	3/4" EK	8	425	43	1	
187913509	1"1/4	3/4" EK	9	475	43	1	
187913510	1"1/4	3/4" EK	10	525	43	1	
187913511	1"1/4	3/4" EK	11	575	43	1	
187913512	1"1/4	3/4" EK	12	625	43	1	
187913513	1"1/4	3/4" EK	13	675	43	1	

## IVR 879/R

NEW

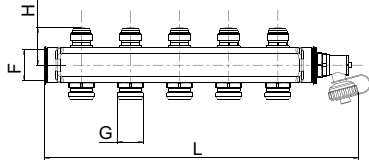

Collettore di mandata con detentori micrometrici e con rubinetto di carico/scarico acqua

Inlet manifold with micrometric lockshields and fill & drain valve

Vorlaufverteiler mit mikrometrischen Rücklaufverschraubungen und Ein-/Ablassventil

Collecteur d'alimentation avec coudes de réglage micrométriques et avec robinet de chargement/déchargement

Входной коллектор с микрометрическими отсекающими вентилями и дренажным клапаном

Cod./Code	(F) Misura/Size	(G) Attacco/Connection	Vie/Ways	L(mm)	H(mm)	□/田	€
1879R11502	1"	3/4" EK	2	169	38	1	
1879R11503	1"	3/4" EK	3	219	38	1	
1879R11504	1"	3/4" EK	4	269	38	1	
1879R11505	1"	3/4" EK	5	319	38	1	
1879R11506	1"	3/4" EK	6	369	38	1	
1879R11507	1"	3/4" EK	7	419	38	1	
1879R11508	1"	3/4" EK	8	469	38	1	
1879R11509	1"	3/4" EK	9	519	38	1	
1879R11510	1"	3/4" EK	10	569	38	1	
1879R11511	1"	3/4" EK	11	619	38	1	
1879R11512	1"	3/4" EK	12	669	38	1	
1879R11513	1"	3/4" EK	13	719	38	1	

## COLLETTORI / MANIFOLDS Collettori Inox / Inox Manifolds AVANT FLOOR BASIC



Collettore in acciaio inox AISI 304 1" - 1"1/4; Interasse: 50 mm

AISI 304 stainless steel manifold 1" - 1"1/4; Center hole distance 50 mm

Verteiler aus rostfreiem Stahl AISI 304 1" - 1"1/4 Anschlüsse; Abstand 50 mm

Collecteur en acier inox AISI 304 1" - 1"1/4; entraxes 50mm

Коллектор из нержавеющей стали AISI 304, размеры 1" - 1"1/4 ; соединения Евроконус, межосевое расстояние 50 мм

## IVR 871

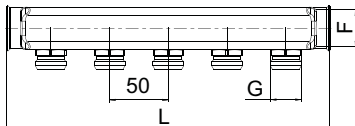

Cod./Code	(F) Misura/Size	(G) Attacco/Connection	Vie/Ways	L(mm)	H(mm)	□/田	€
187111502	1"	3/4" EK	2	125		1	
187111503	1"	3/4" EK	3	175		1	
187111504	1"	3/4" EK	4	225		1	
187111505	1"	3/4" EK	5	275		1	
187111506	1"	3/4" EK	6	325		1	
187111507	1"	3/4" EK	7	375		1	
187111508	1"	3/4" EK	8	425		1	
187111509	1"	3/4" EK	9	475		1	
187111510	1"	3/4" EK	10	525		1	
187111511	1"	3/4" EK	11	575		1	
187111512	1"	3/4" EK	12	625		1	
187111513	1"	3/4" EK	13	675		1	
187113506	1"1/4	3/4" EK	6	325		1	
187113507	1"1/4	3/4" EK	7	375		1	
187113508	1"1/4	3/4" EK	8	425		1	
187113509	1"1/4	3/4" EK	9	475		1	
187113510	1"1/4	3/4" EK	10	525		1	
187113511	1"1/4	3/4" EK	11	575		1	
187113512	1"1/4	3/4" EK	12	625		1	
187113513	1"1/4	3/4" EK	13	675		1	

## IVR 868

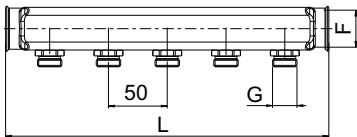

Cod./Code	(F) Misura/Size	(G) Attacco/Connection	Vie/Ways	L(mm)	□/田	€
186811502	1"	1/2"	2	125	1	
186811503	1"	1/2"	3	175	1	
186811504	1"	1/2"	4	225	1	
186811505	1"	1/2"	5	275	1	
186811506	1"	1/2"	6	325	1	
186811507	1"	1/2"	7	375	1	
186811508	1"	1/2"	8	425	1	
186811509	1"	1/2"	9	475	1	
186811510	1"	1/2"	10	525	1	
186811511	1"	1/2"	11	575	1	
186811512	1"	1/2"	12	625	1	
186811513	1"	1/2"	13	675	1	
186813506	1"1/4	1/2"	6	325	1	
186813507	1"1/4	1/2"	7	375	1	
186813508	1"1/4	1/2"	8	425	1	
186813509	1"1/4	1/2"	9	475	1	
186813510	1"1/4	1/2"	10	525	1	
186813511	1"1/4	1/2"	11	575	1	
186813512	1"1/4	1/2"	12	625	1	
186813513	1"1/4	1/2"	13	675	1	

## IVR 869

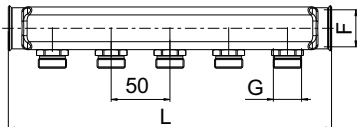

Cod./Code	(F) Misura/Size	(G) Attacco/Connection	Vie/Ways	L(mm)	□/田	€
186911502	1"	24-19	2	125	1	
186911503	1"	24-19	3	175	1	
186911504	1"	24-19	4	225	1	
186911505	1"	24-19	5	275	1	
186911506	1"	24-19	6	325	1	
186911507	1"	24-19	7	375	1	
186911508	1"	24-19	8	425	1	
186911509	1"	24-19	9	475	1	
186911510	1"	24-19	10	525	1	
186911511	1"	24-19	11	575	1	
186911512	1"	24-19	12	625	1	
186911513	1"	24-19	13	675	1	
186913506	1"1/4	24-19	6	325	1	
186913507	1"1/4	24-19	7	375	1	
186913508	1"1/4	24-19	8	425	1	
186913509	1"1/4	24-19	9	475	1	
186913510	1"1/4	24-19	10	525	1	
186913511	1"1/4	24-19	11	575	1	
186913512	1"1/4	24-19	12	625	1	
186913513	1"1/4	24-19	13	675	1	

## IVR 867

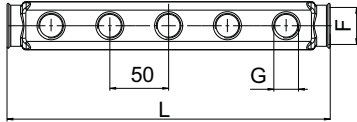

Cod./Code	(F) Misura/Size	(G) Attacco/Connection	Vie/Ways	L(mm)	□/田	€
186711502	1"	1/2" F	2	125	1	
186711503	1"	1/2" F	3	175	1	
186711504	1"	1/2" F	4	225	1	
186711505	1"	1/2" F	5	275	1	
186711506	1"	1/2" F	6	325	1	
186711507	1"	1/2" F	7	375	1	
186711508	1"	1/2" F	8	425	1	
186711509	1"	1/2" F	9	475	1	
186711510	1"	1/2" F	10	525	1	
186711511	1"	1/2" F	11	575	1	
186711512	1"	1/2" F	12	625	1	
186711513	1"	1/2" F	13	675	1	
186713506	1"1/4	1/2" F	6	325	1	
186713507	1"1/4	1/2" F	7	375	1	
186713508	1"1/4	1/2" F	8	425	1	
186713509	1"1/4	1/2" F	9	475	1	
186713510	1"1/4	1/2" F	10	525	1	
186713511	1"1/4	1/2" F	11	575	1	
186713512	1"1/4	1/2" F	12	625	1	
186713513	1"1/4	1/2" F	13	675	1	



## IVR MULTIKLIMA Distribuzione / Distribution



### IVR MULTIKLIMA 525



Interasse attacco tubazioni: 277 mm.  
Pipe connection center to center: 277 mm.

Modulo di distribuzione per alta e bassa temperatura con collettori in acciaio inox AISI 304 da 1" x 3/4" EK da 2 a 12 derivazioni con 2 derivazioni (o 3 su richiesta) per alta temperatura; collettori completi di: valvole d'intercettazione, valvole termostattabili, misuratori di portata, rubinetto orientabile di carico scarico, valvola sfiato aria. Gruppo di miscelazione modulante con servocomando elettrotermico e gruppo by-pass con termostato di sicurezza, detettore micrometrico e pozzetto porta sonda.

Water distribution cabinet for high and low temperature with AISI 304 stainless steel manifolds 1"x3/4" EK, 2-12 ways; with 2 ways (or 3 on demand) for high temperature; fitted with: interception valves, thermostatic valves, flow meters, rotatable drain valve and air vent. Modulating mixing unit with electrothermal actuator and by-pass group with safety thermostat, micrometric lockshield and sensor connection.

Verteilermodul für hohe und niedrige Temperatur mit Verteilerrohren aus rostfreiem Stahl AISI 304 mit Ek Übergang 1"x3/4", mit 2-12 Abzweigungen (oder 3 auf Anfrage) für hohe Temperatur; ausgestattet mit: Absperrventilen, thermostatisierbaren Ventilen, Durchflussmessern, drehbarem Ein-/Ablassventil und Luftablassventil. Modulierende Mischerguppe mit elektrothermischem Servosteuerung und Bypass-Gruppe mit Sicherheitsthermostat, mikrometrischem Regelventil und Sondenaufnahme.

Module de distribution pour haute et basse température, avec collecteurs en acier inoxydable AISI304, de 1" x 3/4" EK e 1" 1/4 x 3/4" EK, à 2 dérivation (ou 3 sur demande) pour température haute; pourvus de: vannes d'arrêt, vannes thermostatiques, débitmètres, robinet orientable de chargement/déchargement, vanne de purge de l'air. Groupe de mélange modulante avec servocommande électrothermique et groupe by-pass avec thermostat de sécurité, coude de réglage micrométrique et puisard porte-sonde.

Распределительный модуль для низкой и высокой температуры с коллекторами сделан из нержавеющей стали AISI 304 1" x 3/4" Евроконус, от 2 до 12 отводов, с двумя ответвлениями (с тремя - под заказ) для высокой температуры. Состоит из: шарового крана для насоса, термостатических клапанов, расходомера, дренажного крана, воздушного клапана и крепления. Также входит: модулирующая смесительная группа с термоэлектрическим приводом и группой бай-пасс с предохранительным термостатом, микрометрическим отсекающим вентилем и подключением температурного зонда.

Cod. Sx/Left	Cod. Dx/Right	Vie/Ways	L(mm)	H(mm)	P(mm)	€
52503232GA	52513232GA	2 + 2	850	750	110	
52503232GB	52513232GB	2 + 3	850	750	110	
52503232GC	52513232GC	2 + 4	850	750	110	
52503232GD	52513232GD	2 + 5	1000	750	110	
52503232GE	52513232GE	2 + 6	1000	750	110	
52503232GF	52513232GF	2 + 7	1000	750	110	
52503232GG	52513232GG	2 + 8	1200	750	110	
52503232GH	52513232GH	2 + 9	1200	750	110	
52503232GJ	52513232GJ	2 + 10	1200	750	110	
52503232GK	52513232GK	2 + 11	1200	750	110	
52503232GL	52513232GL	2 + 12	1300	750	110	

Versione con circolatore volumetrico in Classe A  
Version with Class A volumetric pump  
Ausführung mit Class A Umlaufpumpe  
Version avec class A pompe volumétrique  
Версия с циркуляционным насосом класса A

Cod. Sx/Left	Cod. Dx/Right	Vie/Ways	L(mm)	H(mm)	P(mm)	€
52502232GA	52512232GA	2 + 2	850	750	110	
52502232GB	52512232GB	2 + 3	850	750	110	
52502232GC	52512232GC	2 + 4	850	750	110	
52502232GD	52512232GD	2 + 5	1000	750	110	
52502232GE	52512232GE	2 + 6	1000	750	110	
52502232GF	52512232GF	2 + 7	1000	750	110	
52502232GG	52512232GG	2 + 8	1200	750	110	
52502232GH	52512232GH	2 + 9	1200	750	110	
52502232GJ	52512232GJ	2 + 10	1200	750	110	
52502232GK	52512232GK	2 + 11	1200	750	110	
52502232GL	52512232GL	2 + 12	1300	750	110	

Versione con circolatore a tre velocità (solo per paesi extra CEE)  
Version with 3 speed pump (only for extra CEE country)  
Ausführung mit 3-Gang-Pumpe (nur für Klein CEE-Land)  
Version avec pompe à 3 vitesses (uniquement pour les pays extra CEE)  
Версия с трехскоростным насосом (только для стран, не входящих в ЕС)

Cod. Sx/Left	Cod. Dx/Right	Vie/Ways	L(mm)	H(mm)	P(mm)	€
52501232GA	52511232GA	2 + 2	850	750	110	
52501232GB	52511232GB	2 + 3	850	750	110	
52501232GC	52511232GC	2 + 4	850	750	110	
52501232GD	52511232GD	2 + 5	1000	750	110	
52501232GE	52511232GE	2 + 6	1000	750	110	
52501232GF	52511232GF	2 + 7	1000	750	110	
52501232GG	52511232GG	2 + 8	1200	750	110	
52501232GH	52511232GH	2 + 9	1200	750	110	
52501232GJ	52511232GJ	2 + 10	1200	750	110	
52501232GK	52511232GK	2 + 11	1200	750	110	
52501232GL	52511232GL	2 + 12	1300	750	110	

Versione senza circolatore (con tronchetto spaziatore)  
Version without pump (with pipes premounted)  
Ausführung ohne Pumpe (mit Balken vormontiert)  
Version sans pompe (avec des tuyaux prèmonté)  
Версия без насоса (с предустановленными трубами)

## IVR MULTIKLIMA 523

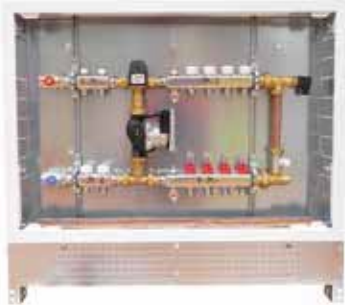

Modulo di distribuzione per alta e bassa temperatura con collettori in acciaio inox AISI 304 da 1" x 3/4" EK da 2 a 12 derivazioni con 2 derivazioni (o 3 su richiesta) per alta temperatura; collettori completi di: valvole d'intercettazione, valvole termostattizzabili, misuratori di portata, rubinetto orientabile di carico scarico, valvola sfiato aria. Gruppo di miscelazione a punto fisso con miscelatore termostatico e gruppo by-pass con termostato di sicurezza, detentore micrometrico e pozzetto porta sonda.

Water distribution cabinet for high and low temperature with AISI 304 stainless steel manifolds 1"x3/4" EK, 2-12 ways; with 2 ways (or 3 on demand) for high temperature; fitted with: interception valves, thermostatic valves, flow meters, rotatable drain valve and air vent. Mixing unit with fixed point with thermostatic head and by-pass group with safety thermostat, micrometric lockshield and sensor connection.

Verteilermodul für hohe und niedrige Temperatur, mit Verteilerröhren aus rostfreiem Stahl AISI 304 mit EK Übergang 1"x3/4", mit 2-12 Abzweigungen (oder 3 auf Anfrage) für hohe Temperatur; ausgestattet mit: Absperrventilen, thermostatisierbaren Ventilen, Durchflussmessern, drehbarem Ein-/Ablassventil und Luftablassventil. Fest eingestellte Mischerguppe mit thermostatischem Kopf und Bypass-Gruppe mit Sicherheitsthermostat, mikrometrischem Regelventil und Sondenaufnahme.

Module de distribution pour haute et basse température avec collecteurs en acier inoxydable AISI304, de 1" x 3/4" EK, à 2 dérivation (ou 3 sur demande) pour température haute; pourvus de: vannes d'arrêt, vannes thermostatisables, débitmètres, robinet orientable de chargement/déchargement, vanne de purge de l'air. Groupe de mélange à point fixe avec mitigeur thermostatique et groupe by-pass avec thermostat de sécurité, coude de réglage micrométrique et puisard porte-sonde.

Распределительный модуль для низкой и высокой температуры с коллекторами из нержавеющей стали AISI 304 1" x 3/4" Евроконус, от 2 до 12 отводов, с двумя ниями (с тремя - под заказ) для высокой температуры. Состоит из: шарового крана для насоса, термостатического клапана (для термостатических головок), расходомера, дренажного крана, воздушного клапана и крепления. Также входит модулирующая смесительная группа с термостатическим вентилем и группой бай-пасс с предохранительным термостатом, микрометрическим отсекающим вентилем и подключением температурного зонда.

Interasse attacco tubazioni: 277 mm.  
 Pipe connection center to center: 277 mm.

Cod. Sx/Left	Cod. Dx/Right	Vie/Ways	L(mm)	H(mm)	P(mm)	€
52303231GA	52313231GA	2 + 2	850	750	110	
52303231GB	52313231GB	2 + 3	850	750	110	
52303231GC	52313231GC	2 + 4	850	750	110	
52303231GD	52313231GD	2 + 5	1000	750	110	
52303231GE	52313231GE	2 + 6	1000	750	110	
52303231GF	52313231GF	2 + 7	1000	750	110	
52303231GG	52313231GG	2 + 8	1200	750	110	
52303231GH	52313231GH	2 + 9	1200	750	110	
52303231GJ	52313231GJ	2 + 10	1200	750	110	
52303231GK	52313231GK	2 + 11	1200	750	110	
52303231GL	52313231GL	2 + 12	1300	750	110	

Versione con circolatore volumetrico in Classe A  
 Version with Class A volumetric pump  
 Ausführung mit Class A Umlaufpumpe  
 Version avec class A pompe volumétrique  
 Версия с циркуляционным насосом класса А

Cod. Sx/Left	Cod. Dx/Right	Vie/Ways	L(mm)	H(mm)	P(mm)	€
52302231GA	52312231GA	2 + 2	850	750	110	
52302231GB	52312231GB	2 + 3	850	750	110	
52302231GC	52312231GC	2 + 4	850	750	110	
52302231GD	52312231GD	2 + 5	1000	750	110	
52302231GE	52312231GE	2 + 6	1000	750	110	
52302231GF	52312231GF	2 + 7	1000	750	110	
52302231GG	52312231GG	2 + 8	1200	750	110	
52302231GH	52312231GH	2 + 9	1200	750	110	
52302231GJ	52312231GJ	2 + 10	1200	750	110	
52302231GK	52312231GK	2 + 11	1200	750	110	
52302231GL	52312231GL	2 + 12	1300	750	110	

Versione con circolatore a tre velocità (solo per paesi extra CEE)  
 Version with 3 speed pump (only for extra CEE country)  
 Ausführung mit 3-Gang-Pumpe (nur für Klein CEE-Land)  
 Version avec pompe à 3 vitesses (uniquement pour les pays extra CEE)  
 Версия с трехскоростным насосом (только для стран, не входящих в ЕС)

Cod. Sx/Left	Cod. Dx/Right	Vie/Ways	L(mm)	H(mm)	P(mm)	€
52301231GA	52311231GA	2 + 2	850	750	110	
52301231GB	52311231GB	2 + 3	850	750	110	
52301231GC	52311231GC	2 + 4	850	750	110	
52301231GD	52311231GD	2 + 5	1000	750	110	
52301231GE	52311231GE	2 + 6	1000	750	110	
52301231GF	52311231GF	2 + 7	1000	750	110	
52301231GG	52311231GG	2 + 8	1200	750	110	
52301231GH	52311231GH	2 + 9	1200	750	110	
52301231GJ	52311231GJ	2 + 10	1200	750	110	
52301231GK	52311231GK	2 + 11	1200	750	110	
52301231GL	52311231GL	2 + 12	1300	750	110	

Versione senza circolatore (con tronchetto spaziatore)  
 Version without pump (with pipes pre-mounted)  
 Ausführung ohne Pumpe (mit Balken vormontiert)  
 Version sans pompe (avec des tuyaux pré-montés)  
 Версия без насоса (с предустановленными трубами)

## IVR MULTIKLIMA 521

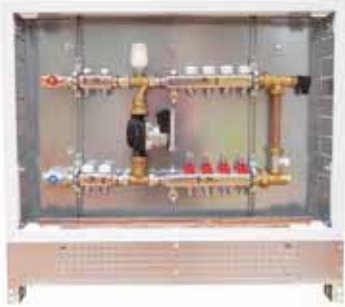

Interasse attacco tubazioni: 277 mm.  
Pipe connection center to center: 277 mm.

Modulo di distribuzione per alta e bassa temperatura con collettori in acciaio inox AISI 304 da 1" x 3/4" EK, da 2 a 12 derivazioni; con 2 derivazioni (o 3 su richiesta) per alta temperatura; collettori completi di: valvole d'intercettazione, valvole termostatzabili, misuratori di portata, rubinetto orientabile di carico scarico, valvola sfiato aria. Gruppo di miscelazione a punto fisso con testa termostatica e gruppo by-pass con termostato di sicurezza, detentore micrometrico e pozzetto porta sonda.

Water distribuion cabinet for high and low temperature with AISI 304 stainless steel manifolds 1"x3/4" EK, 2-12 ways; with 2 ways (or 3 on demand) for high temperature; fitted with: interception valves, thermostatic valves, flow meters, rotatable drain valve and air vent. Mixing unit with fixed point with thermostatic head and by-pass group with safety thermostat, micrometric lockshield and sensor connection.

Verteilermodul für hohe und niedrige Temperatur, mit Verteilerröhren aus rostfreiem Stahl AISI 304 mit Ek Übergang 1"x3/4", mit 2-12 Abzweigungen (oder 3 auf Anfrage) für hohe Temperatur; ausgestattet mit: Absperrventilen, thermostatisierbaren Ventilen, Durchflussmessern, drehbarem Ein-/Ablassventil und Luftablassventil. Fest eingestellte Mischerguppe mit thermostatischem Kopf und Bypass-Gruppe mit Sicherheitsthermostat, mikrometrischem Regelventil und Sondenaufnahme.

Module de distribution pour haute et basse température avec collecteurs en acier inoxydable AISI304, de 1" x 3/4" EK, à 2 dérivation (ou 3 sur demande) pour température haute; pourvus de: vannes d'arrêt, vannes thermostatisables, débitmètres, robinet orientable de chargement/déchargement, vanne de purge de l'air. Groupe de mélange à point fixe avec tête thermostatique et groupe by-pass avec thermostat de sécurité, coude de réglage micrométrique et puisard porte-sonde.

Распределительный модуль для низкой и высокой температуры с коллекторами и гидравлическим сепаратором сделан из нержавеющей стали AISI 304 1" x 3/4" Евроконус, от 2 до 12 отводов, с двумя ответвлениями (с тремя - под заказ) для высокой температуры. Состоит из: шарового крана для насоса, термостатического клапана (для термостатических головок), расходомера, дренажного крана, воздушного клапана и крепления. Также входит модулирующая смесительная группа с термостатической головкой и группой бай-пасс с предохранительным термостатом, микрометрическим отсекающим вентилем и подключением температурного зонда.

Cod. Sx/Left	Cod. Dx/Right	Vie/Ways	L(mm)	H(mm)	P(mm)	€
52103230GA	52113230GA	2 + 2	850	750	110	
52103230GB	52113230GB	2 + 3	850	750	110	
52103230GC	52113230GC	2 + 4	850	750	110	
52103230GD	52113230GD	2 + 5	1000	750	110	
52103230GE	52113230GE	2 + 6	1000	750	110	
52103230GF	52113230GF	2 + 7	1000	750	110	
52103230GG	52113230GG	2 + 8	1200	750	110	
52103230GH	52113230GH	2 + 9	1200	750	110	
52103230GJ	52113230GJ	2 + 10	1200	750	110	
52103230GK	52113230GK	2 + 11	1200	750	110	
52103230GL	52113230GL	2 + 12	1300	750	110	

Versione con circolatore volumetrico in Classe A  
Version with Class A volumetric pump  
Ausführung mit Class A Umlaufpumpe  
Version avec class A pompe volumétrique  
Версия с циркуляционным насосом класса А

Cod. Sx/Left	Cod. Dx/Right	Vie/Ways	L(mm)	H(mm)	P(mm)	€
52102230GA	52112230GA	2 + 2	850	750	110	
52102230GB	52112230GB	2 + 3	850	750	110	
52102230GC	52112230GC	2 + 4	850	750	110	
52102230GD	52112230GD	2 + 5	1000	750	110	
52102230GE	52112230GE	2 + 6	1000	750	110	
52102230GF	52112230GF	2 + 7	1000	750	110	
52102230GG	52112230GG	2 + 8	1200	750	110	
52102230GH	52112230GH	2 + 9	1200	750	110	
52102230GJ	52112230GJ	2 + 10	1200	750	110	
52102230GK	52112230GK	2 + 11	1200	750	110	
52102230GL	52112230GL	2 + 12	1300	750	110	

Versione con circolatore a tre velocità (solo per paesi extra CEE)  
Version with 3 speed pump (only for extra CEE country)  
Ausführung mit 3-Gang-Pumpe (nur für Klein CEE-Land)  
Version avec pompe à 3 vitesses (uniquement pour les pays extra CEE)  
Версия с трехскоростным насосом (только для стран, не входящих в ЕС)

Cod. Sx/Left	Cod. Dx/Right	Vie/Ways	L(mm)	H(mm)	P(mm)	€
52101230GA	52111230GA	2 + 2	850	750	110	
52101230GB	52111230GB	2 + 3	850	750	110	
52101230GC	52111230GC	2 + 4	850	750	110	
52101230GD	52111230GD	2 + 5	1000	750	110	
52101230GE	52111230GE	2 + 6	1000	750	110	
52101230GF	52111230GF	2 + 7	1000	750	110	
52101230GG	52111230GG	2 + 8	1200	750	110	
52101230GH	52111230GH	2 + 9	1200	750	110	
52101230GJ	52111230GJ	2 + 10	1200	750	110	
52101230GK	52111230GK	2 + 11	1200	750	110	
52101230GL	52111230GL	2 + 12	1300	750	110	

Versione senza circolatore (con tronchetto spaziatore)  
Version without pump (with pipes premounted)  
Ausführung ohne Pumpe (mit Balken vormontiert)  
Version sans pompe (avec des tuyaux prémonté)  
Версия без насоса (с предустановленными трубами)

## IVR MULTIKLIMA 516



Interasse attacco tubazioni: 150 mm.  
 Pipe connection center to center: 150 mm.

Modulo di distribuzione per bassa temperatura, con separatore idraulico in acciaio inox, con collettori in acciaio inox AISI 304 da 1" x 3/4" EK, da 2 a 12 derivazioni; completi di: valvole d'intercettazione, valvole termostattizzabili, misuratori di portata, rubinetto orientabile di carico scarico, valvola sfiato aria. Gruppo di miscelazione modulante con servocomando elettrotermico, gruppo by-pass con termostato di sicurezza, detentore micrometrico e pozzetto porta sonda.

Mixing unit for low temperature with hydraulic separator, with AISI 304 stainless steel manifolds 1"x3/4" EK, 2-12 ways; fitted with: interception valves, thermostatic valves, flow meters, rotatable drain valve and air vent. Modulating mixing unit with electrothermal actuator, by-pass group with safety thermostat, micrometric lockshield and sensor connection.

Verteilermodul für niedrige Temperatur, mit hydraulischer Weiche aus rostfreiem Stahl und mit Verteilerröhren aus rostfreiem Stahl AISI 304 mit Ek Übergang 1"x3/4", mit 2-12 Abzweigungen; ausgestattet mit: Absperrventilen, thermostatisierbaren Ventilen, Durchflussmessern, drehbarem Ein-/Ablassventil und Luftablassventil. Fest eingestellte Mischerguppe mit elektrothermischer Servosteuerung, Bypass-Gruppe mit Sicherheitsthermostat, mikrometrischem Regelventil und Sondenaufnahme.

Module de distribution pour basse température avec séparateur hydraulique en acier inoxydable et avec collecteurs en acier inoxydable AISI304, de 1" x 3/4" EK, à 2-12 dérivation; pourvus de: vannes d'arrêt, vannes thermostatissables, débitmètres, robinet orientable de chargement/déchargement, vanne de purge de l'air. Groupe de mélange modulante avec servocommande électrothermique, groupe by-pass avec thermostat de sécurité, coude de réglage micrométrique, puisard porte-sonde et séparateur hydraulique en acier inoxydable.

Распределительный модуль с коллекторами и гидравлическим сепаратором из нержавеющей стали AISI 304 1" x 3/4" Евроконус, от 2 до 12 отводов для низкой температуры состоит из: шарового крана для насоса, термостатического клапана (для термостатических головок), расходомера, дренажного крана, воздушного клапана и крепления. Также входит модулирующая смешивательная группа с термоэлектрическим приводом и группой бай-пасс с предохранительным термостатом, микрометрическим отсекающим вентилем и подключением температурного зонда.

Cod. Sx/Left	Cod. Dx/Right	Vie/Ways	L(mm)	H(mm)	P(mm)	€
51603232BA	51613232BA	2	850	750	110	
51603232BB	51613232BB	3	850	750	110	
51603232BC	51613232BC	4	850	750	110	
51603232BD	51613232BD	5	1000	750	110	
51603232BE	51613232BE	6	1000	750	110	
51603232BF	51613232BF	7	1000	750	110	
51603232BG	51613232BG	8	1200	750	110	
51603232BH	51613232BH	9	1200	750	110	
51603232BJ	51613232BJ	10	1200	750	110	
51603232BK	51613232BK	11	1200	750	110	
51603232BL	51613232BL	12	1300	750	110	

Versione con circolatore volumetrico in Classe A  
 Version with Class A volumetric pump  
 Ausführung mit Class A Umlaufpumpe  
 Version avec class A pompe volumétrique  
 Версия с циркуляционным насосом класса А

Cod. Sx/Left	Cod. Dx/Right	Vie/Ways	L(mm)	H(mm)	P(mm)	€
51602232BA	51612232BA	2	850	750	110	
51602232BB	51612232BB	3	850	750	110	
51602232BC	51612232BC	4	850	750	110	
51602232BD	51612232BD	5	1000	750	110	
51602232BE	51612232BE	6	1000	750	110	
51602232BF	51612232BF	7	1000	750	110	
51602232BG	51612232BG	8	1200	750	110	
51602232BH	51612232BH	9	1200	750	110	
51602232BJ	51612232BJ	10	1200	750	110	
51602232BK	51612232BK	11	1200	750	110	
51602232BL	51612232BL	12	1300	750	110	

Versione con circolatore a tre velocità (solo per paesi extra CEE)  
 Version with 3 speed pump (only for extra CEE country)  
 Ausführung mit 3-Gang-Pumpe (nur für Klein CEE-Land)  
 Version avec pompe à 3 vitesses (uniquement pour les pays extra CEE)  
 Версия с трехскоростным насосом (только для стран, не входящих в ЕС)

Cod. Sx/Left	Cod. Dx/Right	Vie/Ways	L(mm)	H(mm)	P(mm)	€
51601232BA	51611232BA	2	850	750	110	
51601232BB	51611232BB	3	850	750	110	
51601232BC	51611232BC	4	850	750	110	
51601232BD	51611232BD	5	1000	750	110	
51601232BE	51611232BE	6	1000	750	110	
51601232BF	51611232BF	7	1000	750	110	
51601232BG	51611232BG	8	1200	750	110	
51601232BH	51611232BH	9	1200	750	110	
51601232BJ	51611232BJ	10	1200	750	110	
51601232BK	51611232BK	11	1200	750	110	
51601232BL	51611232BL	12	1300	750	110	

Versione senza circolatore (con tronchetto spaziatore)  
 Version without pump (with pipes pre-mounted)  
 Ausführung ohne Pumpe (mit Balken vormontiert)  
 Version sans pompe (avec des tuyaux prémonté)  
 Версия без насоса (с предустановленными трубами)

## IVR MULTIKLIMA 515



Interasse attacco tubazioni: 277 mm.  
Pipe connection center to center: 277 mm.

Modulo di distribuzione per bassa temperatura, con separatore idraulico in acciaio inox, con collettori in acciaio inox AISI 304 da 1" x 3/4" EK, da 2 a 12 derivazioni; completi di: valvole d'intercettazione, valvole termostattizzabili, misuratori di portata, rubinetto orientabile di carico scarico, valvola sfiato aria. Gruppo di miscelazione modulante con servocomando elettrotermico, gruppo by-pass con termostato di sicurezza, detentore micrometrico e pozzetto porta sonda.

Mixing unit for low temperature with hydraulic separator, with AISI 304 stainless steel manifolds 1"x3/4" EK, 2-12 ways; fitted with: interception valves, thermostatic valves, flow meters, rotatable drain valve and air vent. Modulating mixing unit with electrothermal actuator, by-pass group with safety thermostat, micrometric lockshield and sensor connection.

Verteilermodul für niedrige Temperatur, mit hydraulischer Weiche aus rostfreiem Stahl und mit Verteilerrohren aus rostfreiem Stahl AISI 304 mit Ek Übergang 1"x3/4", mit 2-12 Abzweigungen; ausgestattet mit: Absperrventilen, thermostatisierbaren Ventilen, Durchflussmessern, drehbarem Ein-/Ablassventil und Luftablassventil. Fest eingestellte Mischerguppe mit elektrothermischer Servosteuerung, Bypass-Gruppe mit Sicherheitsthermostat, mikrometrischem Regelventil und Sondenaufnahme.

Module de distribution pour basse température avec séparateur hydraulique en acier inoxydable et avec collecteurs en acier inoxydable AISI304, de 1" x 3/4" EK, à 2-12 dérivation; pourvus de: vannes d'arrêt, vannes thermostatisables, débitmètres, robinet orientable de chargement/déchargement, vanne de purge de l'air. Groupe de mélange modulante avec servocommande électrothermique, groupe by-pass avec thermostat de sécurité, coude de réglage micrométrique, puisard porte-sonde et séparateur hydraulique en acier inoxydable.

Распределительный модуль с коллекторами и гидравлическим сепаратором из нержавеющей стали AISI 304 1" x 3/4" Евроконус, от 2 до 12 отводов для низкой температуры состоит из: шарового крана для насоса, термостатического клапана (для термостатических головок), расходомера, дренажного крана, воздушного клапана и крепления. Также входит модулирующая смешивающая группа с термозлектрическим приводом и группой бай-пасс с предохранительным термостатом, микрометрическим отсекающим вентилем и подключением температурного зонда.

Cod. Sx/Left	Cod. Dx/Right	Vie/Ways	L(mm)	H(mm)	P(mm)	€
51503232BA	51513232BA	2	600	750	110	
51503232BB	51513232BB	3	700	750	110	
51503232BC	51513232BC	4	700	750	110	
51503232BD	51513232BD	5	850	750	110	
51503232BE	51513232BE	6	850	750	110	
51503232BF	51513232BF	7	850	750	110	
51503232BG	51513232BG	8	1000	750	110	
51503232BH	51513232BH	9	1000	750	110	
51503232BJ	51513232BJ	10	1000	750	110	
51503232BK	51513232BK	11	1200	750	110	
51503232BL	51513232BL	12	1200	750	110	

Versione con circolatore volumetrico in Classe A  
Version with Class A volumetric pump  
Ausführung mit Class A Umlaufpumpe  
Version avec class A pompe volumétrique  
Версия с циркуляционным насосом класса А

Cod. Sx/Left	Cod. Dx/Right	Vie/Ways	L(mm)	H(mm)	P(mm)	€
51502232BA	51512232BA	2	600	750	110	
51502232BB	51512232BB	3	700	750	110	
51502232BC	51512232BC	4	700	750	110	
51502232BD	51512232BD	5	850	750	110	
51502232BE	51512232BE	6	850	750	110	
51502232BF	51512232BF	7	850	750	110	
51502232BG	51512232BG	8	1000	750	110	
51502232BH	51512232BH	9	1000	750	110	
51502232BJ	51512232BJ	10	1000	750	110	
51502232BK	51512232BK	11	1200	750	110	
51502232BL	51512232BL	12	1200	750	110	

Versione con circolatore a tre velocità (solo per paesi extra CEE)  
Version with 3 speed pump (only for extra CEE country)  
Ausführung mit 3-Gang-Pumpe (nur für Klein CEE-Land)  
Version avec pompe à 3 vitesses (uniquement pour les pays extra CEE)  
Версия с трехскоростным насосом (только для стран, не входящих в ЕС)

Cod. Sx/Left	Cod. Dx/Right	Vie/Ways	L(mm)	H(mm)	P(mm)	€
51501232BA	51511232BA	2	600	750	110	
51501232BB	51511232BB	3	700	750	110	
51501232BC	51511232BC	4	700	750	110	
51501232BD	51511232BD	5	850	750	110	
51501232BE	51511232BE	6	850	750	110	
51501232BF	51511232BF	7	850	750	110	
51501232BG	51511232BG	8	1000	750	110	
51501232BH	51511232BH	9	1000	750	110	
51501232BJ	51511232BJ	10	1000	750	110	
51501232BK	51511232BK	11	1200	750	110	
51501232BL	51511232BL	12	1200	750	110	

Versione senza circolatore (con tronchetto spaziatore)  
Version without pump (with pipes pre-mounted)  
Ausführung ohne Pumpe (mit Balken vormontiert)  
Version sans pompe (avec des tuyaux pré-monté)  
Версия без насоса (с предустановленными трубами)



## IVR MULTIKLIMA 514



Interasse attacco tubazioni: 150 mm.  
 Pipe connection center to center: 150 mm.

Modulo di distribuzione per bassa temperatura, con separatore idraulico in acciaio inox, con collettori in acciaio inox AISI 304 da 1" x 3/4" EK, da 2 a 12 derivazioni; completi di: valvola d'intercettazione, valvole termostattizzabili, misuratori di portata, rubinetto orientabile di carico scarico, valvola sfiato aria. Gruppo di miscelazione a punto fisso con miscelatore termostatico, gruppo by-pass con termostato di sicurezza, detentore micrometrico e pozzetto porta sonda.

Water distribution cabinet for low temperature with stainless steel hydraulic separator and with AISI 304 stainless steel manifolds 1"x3/4" EK, 2-12 ways; fitted with: interception valve, thermostatic valves, flow meters, rotatable drain valves and air vent. Mixing unit with fixed point with thermostatic mixing valve, by-pass group with safety thermostat, micrometric lockshield and sensor connection.

Verteilermodule für niedrige Temperatur mit hydraulischer Weiche aus rostfreiem Stahl und mit Verteilerröhren aus rostfreiem Stahl AISI 304 mit Ek Übergang 1"x3/4", mit 2-12 Abzweigungen; ausgestattet mit: Absperrventil, thermostatisierbaren Ventilen, Durchflussmessern, drehbarem Ein-/Ablassventil und Luftablassventil. Fest eingestellte Mischerguppe mit thermostatischem Mischer, Bypass-Gruppe mit Sicherheitsthermostat, mikrometrischem Regelventil und Sondenaufnahme.

Module de distribution pour basse température, avec collecteurs en acier inoxydable AISI304, de 1" x 3/4" EK, à 2-12 dérivation; pourvus de: vanne d'arrêt, vannes thermostatisables, débitmètres, robinet orientable de chargement/déchargement, vanne de purge de l'air. Groupe de mélange à point fixe avec mitigeur thermostatique, groupe by-pass avec thermostat de sécurité, coude de réglage micrométrique et puisard porte-sonde, séparateur hydraulique en acier inoxydable et séparateur hydraulique en acier inoxydable.

Распределительный модуль с коллекторами и гидравлическим сепаратором из нержавеющей стали AISI 304 1" x 3/4" Евроконус, от 2 до 12 отводов для низкой температуры состоит из: шарового крана для насоса, терmostатического клапана (для терmostатических головок), расходомера, дренажного крана, воздушного клапана и крепления. Также входит модулирующая смешивательная группа с терmostатическим вентилем и группой бай-пасс с предохранительным терmostатом, микрометрическим отсекающим вентилем и подключением температурного зонда.

Cod. Sx/Left	Cod. Dx/Right	Vie/Ways	L(mm)	H(mm)	P(mm)	€
51403231BA	51413231BA	2	850	750	110	
51403231BB	51413231BB	3	850	750	110	
51403231BC	51413231BC	4	850	750	110	
51403231BD	51413231BD	5	1000	750	110	
51403231BE	51413231BE	6	1000	750	110	
51403231BF	51413231BF	7	1000	750	110	
51403231BG	51413231BG	8	1200	750	110	
51403231BH	51413231BH	9	1200	750	110	
51403231BJ	51413231BJ	10	1200	750	110	
51403231BK	51413231BK	11	1200	750	110	
51403231BL	51413231BL	12	1300	750	110	

Versione con circolatore volumetrico in Classe A  
 Version with Class A volumetric pump  
 Ausführung mit Class A Umlaufpumpe  
 Version avec class A pompe volumétrique  
 Версия с циркуляционным насосом класса A

Cod. Sx/Left	Cod. Dx/Right	Vie/Ways	L(mm)	H(mm)	P(mm)	€
51402231BA	51412231BA	2	850	750	110	
51402231BB	51412231BB	3	850	750	110	
51402231BC	51412231BC	4	850	750	110	
51402231BD	51412231BD	5	1000	750	110	
51402231BE	51412231BE	6	1000	750	110	
51402231BF	51412231BF	7	1000	750	110	
51402231BG	51412231BG	8	1200	750	110	
51402231BH	51412231BH	9	1200	750	110	
51402231BJ	51412231BJ	10	1200	750	110	
51402231BK	51412231BK	11	1200	750	110	
51402231BL	51412231BL	12	1300	750	110	

Versione con circolatore a tre velocità (solo per paesi extra CEE)  
 Version with 3 speed pump (only for extra CEE country)  
 Ausführung mit 3-Gang-Pumpe (nur für Klein CEE-Land)  
 Version avec pompe à 3 vitesses (uniquement pour les pays extra CEE)  
 Версия с трехскоростным насосом (только для стран, не входящих в ЕС)

Cod. Sx/Left	Cod. Dx/Right	Vie/Ways	L(mm)	H(mm)	P(mm)	€
51401231BA	51411231BA	2	850	750	110	
51401231BB	51411231BB	3	850	750	110	
51401231BC	51411231BC	4	850	750	110	
51401231BD	51411231BD	5	1000	750	110	
51401231BE	51411231BE	6	1000	750	110	
51401231BF	51411231BF	7	1000	750	110	
51401231BG	51411231BG	8	1200	750	110	
51401231BH	51411231BH	9	1200	750	110	
51401231BJ	51411231BJ	10	1200	750	110	
51401231BK	51411231BK	11	1200	750	110	
51401231BL	51411231BL	12	1300	750	110	

Versione senza circolatore (con tronchetto spaziatore)  
 Version without pump (with pipes pre-mounted)  
 Ausführung ohne Pumpe (mit Balken vormontiert)  
 Version sans pompe (avec des tuyaux pré-monté)  
 Версия без насоса (с предустановленными трубами)

## IVR MULTIKLIMA 513



Interasse attacco tubazioni: 277 mm.  
Pipe connection center to center: 277 mm.

Modulo di distribuzione per bassa temperatura con collettori in acciaio inox AISI 304 da 1" x 3/4" EK, da 2 a 12 derivazioni; completi di: valvola d'intercettazione, valvole termostattizzabili, misuratori di portata, rubinetto orientabile di carico scarico, valvola sfiato aria. Gruppo di miscelazione a punto fisso con miscelatore termostatico, gruppo by-pass con termostato di sicurezza, detentore micrometrico e pozzetto porta sonda.

Water distribution cabinet for low temperature with AISI 304 stainless steel manifolds 1"x3/4" EK, 2-12 ways; fitted with: interception valve, thermostatic valves, flow meters, rotatable drain valves and air vent. Mixing unit with fixed point with thermostatic mixing valve, by-pass group with safety thermostat, micrometric lockshield and sensor connection.

Verteilermodul für niedrige Temperatur mit Verteilerrohren aus rostfreiem Stahl AISI 304 mit Ek Übergang 1"x3/4", mit 2-12 Abzweigungen; ausgestattet mit: Absperrventil, thermostatisierbaren Ventilen, Durchflussmessern, drehbarem Ein-/Ablassventil und Luftablassventil. Fest eingestellte Mischerguppe mit Thermostatmischer, Bypass-Gruppe mit Sicherheitsthermostat, mikrometrischem Regelventil und Sondenaufnahme.

Module de distribution pour basse température, avec collecteurs en acier inoxydable AISI304, de 1" x 3/4" EK, à 2-12 dérivation; pourvus de: vanne d'arrêt, vannes thermostatisables, débitmètres, robinet orientable de chargement/déchargement, vanne de purge de l'air. Groupe de mélange à point fixe avec mélangeur thermostatique, groupe by-pass avec thermostat de sécurité, coude de réglage micrométrique et puisard porte-sonde.

Распределительный модуль с коллекторами из нержавеющей стали AISI 304 1" x 3/4" Евроконус, от 2 до 12 отводов для низкой температуры состоит из: шарового крана для насоса, термостатического клапана (для термостатических головок), расходомера, дренажного крана, воздушного клапана и крепления. Также входит модулирующая смесительная группа с термостатическим вентилем и группой бай-пасс с предохранительным термостатом, микрометрическим отсекающим вентилем и подключением температурного зонда.

Cod. Sx/Left	Cod. Dx/Right	Vie/Ways	L(mm)	H(mm)	P(mm)	€
51303231BA	51313231BA	2	600	750	110	
51303231BB	51313231BB	3	700	750	110	
51303231BC	51313231BC	4	700	750	110	
51303231BD	51313231BD	5	850	750	110	
51303231BE	51313231BE	6	850	750	110	
51303231BF	51313231BF	7	850	750	110	
51303231BG	51313231BG	8	1000	750	110	
51303231BH	51313231BH	9	1000	750	110	
51303231BJ	51313231BJ	10	1000	750	110	
51303231BK	51313231BK	11	1200	750	110	
51303231BL	51313231BL	12	1200	750	110	

Versione con circolatore volumetrico in Classe A  
Version with Class A volumetric pump  
Ausführung mit Class A Umlaufpumpe  
Version avec class A pompe volumétrique  
Версия с циркуляционным насосом класса А

Cod. Sx/Left	Cod. Dx/Right	Vie/Ways	L(mm)	H(mm)	P(mm)	€
51302231BA	51312231BA	2	600	750	110	
51302231BB	51312231BB	3	700	750	110	
51302231BC	51312231BC	4	700	750	110	
51302231BD	51312231BD	5	850	750	110	
51302231BE	51312231BE	6	850	750	110	
51302231BF	51312231BF	7	850	750	110	
51302231BG	51312231BG	8	1000	750	110	
51302231BH	51312231BH	9	1000	750	110	
51302231BJ	51312231BJ	10	1000	750	110	
51302231BK	51312231BK	11	1200	750	110	
51302231BL	51312231BL	12	1200	750	110	

Versione con circolatore a tre velocità (solo per paesi extra CEE)  
Version with 3 speed pump (only for extra CEE country)  
Ausführung mit 3-Gang-Pumpe (nur für Klein CEE-Land)  
Version avec pompe à 3 vitesses (uniquement pour les pays extra CEE)  
Версия с трехскоростным насосом (только для стран, не входящих в ЕС)

Cod. Sx/Left	Cod. Dx/Right	Vie/Ways	L(mm)	H(mm)	P(mm)	€
51301231BA	51311231BA	2	600	750	110	
51301231BB	51311231BB	3	700	750	110	
51301231BC	51311231BC	4	700	750	110	
51301231BD	51311231BD	5	850	750	110	
51301231BE	51311231BE	6	850	750	110	
51301231BF	51311231BF	7	850	750	110	
51301231BG	51311231BG	8	1000	750	110	
51301231BH	51311231BH	9	1000	750	110	
51301231BJ	51311231BJ	10	1000	750	110	
51301231BK	51311231BK	11	1200	750	110	
51301231BL	51311231BL	12	1200	750	110	

Versione senza circolatore (con tronchetto spaziatore)  
Version without pump (with pipes pre-mounted)  
Ausführung ohne Pumpe (mit Balken vormontiert)  
Version sans pompe (avec des tuyaux pré-monté)  
Версия без насоса (с предустановленными трубами)

## IVR MULTIKLIMA 512



Interasse attacco tubazioni: 150 mm.  
Pipe connection center to center: 150 mm.

Modulo di distribuzione per bassa temperatura, con separatore idraulico in acciaio inox, con collettori in acciaio inox AISI 304 da 1" x 3/4" EK, da 2 a 12 derivazioni; completi di: valvola d'intercettazione, valvole termostattizzabili, misuratori di portata, rubinetto orientabile di carico scarico, valvola sfiato aria. Gruppo di miscelazione a punto fisso con testa termostatica, gruppo by-pass con termostato di sicurezza, detentore micrometrico e pozzetto porta sonda.

Water distribution cabinet for low temperature with stainless steel hydraulic separator and with AISI 304 stainless steel manifolds 1"x3/4" EK, 2-12 ways; fitted with: interception valve, thermostatic valves, flow meters, rotatable drain valves and air vent. Mixing unit with fixed point with thermostatic head, by-pass group with safety thermostat, micrometric lockshield and sensor connection.

Verteilermodul für niedrige Temperatur, mit hydraulischer Weiche aus rostfreiem Stahl und mit Verteilerrohren aus rostfreiem Stahl AISI 304 mit Ek Übergang 1"x3/4", mit 2-12 Abzweigungen; ausgestattet mit: Absperrventil, thermostatisierbaren Ventilen, Durchflussmessern, drehbarem Ein-/Ablassventil und Luftablassventil. Fest eingestellte Mischerguppe mit thermostatischem Kopf, Bypass-Gruppe mit Sicherheitsthermostat, mikrometrischem Regelventil und Sondenaufnahme.

Module de distribution pour basse température, avec séparateur hydraulique en acier inoxydable et avec collecteurs en acier inoxydable AISI304, de 1" x 3/4" EK, à 2-12 dérivation; pourvus de: vannes d'arrêt, vanne thermostatizables, débitmètres, robinet orientable de chargement/déchargement, vanne de purge de l'air. Groupe de mélange à point fixe avec tête thermostatique, groupe by-pass avec thermostat de sécurité, coude de réglage micrométrique puisard porte-sonde.

Распределительный модуль с коллекторами и гидравлическим сепаратором из нержавеющей стали AISI 304 1" x 3/4" Евроконус, от 2 до 12 отводов для низкой температуры состоит из: шарового крана для насоса, термостатического клапана (для термостатических головок), расходомера, дренажного крана, воздушного клапана и крепления. Также входит модулирующая смесительная группа с термостатической головкой и группой бай-пасс с предохранительным термостатом, микрометрическим отсекающим вентилем и подключением температурного зонда.

Cod. Sx/Left	Cod. Dx/Right	Vie/Ways	L(mm)	H(mm)	P(mm)	€
51203230BA	51213230BA	2	850	750	110	
51203230BB	51213230BB	3	850	750	110	
51203230BC	51213230BC	4	850	750	110	
51203230BD	51213230BD	5	1000	750	110	
51203230BE	51213230BE	6	1000	750	110	
51203230BF	51213230BF	7	1000	750	110	
51203230BG	51213230BG	8	1200	750	110	
51203230BH	51213230BH	9	1200	750	110	
51203230BJ	51213230BJ	10	1200	750	110	
51203230BK	51213230BK	11	1200	750	110	
51203230BL	51213230BL	12	1300	750	110	

Versione con circolatore volumetrico in Classe A  
Version with Class A volumetric pump  
Ausführung mit Class A Umlaufpumpe  
Version avec class A pompe volumétrique  
Версия с циркуляционным насосом класса A

Cod. Sx/Left	Cod. Dx/Right	Vie/Ways	L(mm)	H(mm)	P(mm)	€
51202230BA	51212230BA	2	850	750	110	
51202230BB	51212230BB	3	850	750	110	
51202230BC	51212230BC	4	850	750	110	
51202230BD	51212230BD	5	1000	750	110	
51202230BE	51212230BE	6	1000	750	110	
51202230BF	51212230BF	7	1000	750	110	
51202230BG	51212230BG	8	1200	750	110	
51202230BH	51212230BH	9	1200	750	110	
51202230BJ	51212230BJ	10	1200	750	110	
51202230BK	51212230BK	11	1200	750	110	
51202230BL	51212230BL	12	1300	750	110	

Versione con circolatore a tre velocità (solo per paesi extra CEE)  
Version with 3 speed pump (only for extra CEE country)  
Ausführung mit 3-Gang-Pumpe (nur für Klein CEE-Land)  
Version avec pompe à 3 vitesses (uniquement pour les pays extra CEE)  
Версия с трехскоростным насосом (только для стран, не входящих в ЕС)

Cod. Sx/Left	Cod. Dx/Right	Vie/Ways	L(mm)	H(mm)	P(mm)	€
51201230BA	51211230BA	2	850	750	110	
51201230BB	51211230BB	3	850	750	110	
51201230BC	51211230BC	4	850	750	110	
51201230BD	51211230BD	5	1000	750	110	
51201230BE	51211230BE	6	1000	750	110	
51201230BF	51211230BF	7	1000	750	110	
51201230BG	51211230BG	8	1200	750	110	
51201230BH	51211230BH	9	1200	750	110	
51201230BJ	51211230BJ	10	1200	750	110	
51201230BK	51211230BK	11	1200	750	110	
51201230BL	51211230BL	12	1300	750	110	

Versione senza circolatore (con tronchetto spaziatore)  
Version without pump (with pipes pre-mounted)  
Ausführung ohne Pumpe (mit Balken vormontiert)  
Version sans pompe (avec des tuyaux pré-montés)  
Версия без насоса (с предустановленными трубами)

## IVR MULTIKLIMA 511



Interasse attacco tubazioni: 277 mm.  
Pipe connection center to center: 277 mm.

Modulo di distribuzione per bassa temperatura con collettori in acciaio inox AISI 304 da 1" x 3/4" EK, da 2 a 12 derivazioni; completi di: valvola d'intercettazione, valvole termostattizzabili, misuratori di portata, rubinetto orientabile di carico scarico, valvola sfiato aria. Gruppo di miscelazione a punto fisso con testa termostatica, gruppo by-pass con termostato di sicurezza, detentore micrometrico e pozzetto porta sonda.

Water distribution cabinet for low temperature with AISI 304 stainless steel manifolds 1"x3/4" EK, 2-12 ways; fitted with: interception valve, thermostatic valves, flow meters, rotatable drain valves and air vent. Mixing unit with fixed point with thermostatic head, by-pass group with safety thermostat, micrometric lockshield and sensor connection.

Verteilermodul für niedrige Temperatur mit Verteilerrohren aus rostfreiem Stahl AISI 304 mit Ek Übergang 1"x3/4", mit 2-12 Abzweigungen; ausgestattet mit: Absperrventilen, thermostatisierbaren Ventilen, Durchflussmessern, drehbarem Ein-/Ablassventil und Luftablassventil. Fest eingestellte Mischgruppe mit thermostatischem Kopf, Bypass-Gruppe mit Sicherheitsthermostat, mikrometrischem Regelventil und Sondenaufnahme.

Module de distribution pour basse température, avec collecteurs en acier inoxydable AISI304 de 1" x 3/4" EK, à 2-12 dérivation; pourvus de: vannes d'arrêt, vannes thermostatisables, débitmètres, robinet orientable de chargement/déchargement, vanne de purge de l'air. Groupe de mélange à point fixe avec tête thermostatique, groupe by-pass avec thermostat de sécurité, coude de réglage micrométrique et poussoir porte-sonde.

Распределительный модуль с коллекторами из нержавеющей стали AISI 304 1" x 3/4" Евроконус, от 2 до 12 отводов для низкой температуры состоит из: шарового крана для насоса, термостатического клапана (для термостатических головок), расходомера, дренажного крана, воздушного клапана и крепления. Также входит модулирующая смесительная группа с термостатической головкой и группой бай-пасс с предохранительным термостатом, микрометрическим отсекающим вентилем и подключением температурного зонда.

Cod. Sx/Left	Cod. Dx/Right	Vie/Ways	L(mm)	H(mm)	P(mm)	€
51103230BA	51113230BA	2	600	750	110	
51103230BB	51113230BB	3	700	750	110	
51103230BC	51113230BC	4	700	750	110	
51103230BD	51113230BD	5	850	750	110	
51103230BE	51113230BE	6	850	750	110	
51103230BF	51113230BF	7	850	750	110	
51103230BG	51113230BG	8	1000	750	110	
51103230BH	51113230BH	9	1000	750	110	
51103230BJ	51113230BJ	10	1000	750	110	
51103230BK	51113230BK	11	1200	750	110	
51103230BL	51113230BL	12	1200	750	110	

Versione con circolatore volumetrico in Classe A  
Version with Class A volumetric pump  
Ausführung mit Class A Umlaufpumpe  
Version avec class A pompe volumétrique  
Версия с циркуляционным насосом класса А

Cod. Sx/Left	Cod. Dx/Right	Vie/Ways	L(mm)	H(mm)	P(mm)	€
51102230BA	51112230BA	2	600	750	110	
51102230BB	51112230BB	3	700	750	110	
51102230BC	51112230BC	4	700	750	110	
51102230BD	51112230BD	5	850	750	110	
51102230BE	51112230BE	6	850	750	110	
51102230BF	51112230BF	7	850	750	110	
51102230BG	51112230BG	8	1000	750	110	
51102230BH	51112230BH	9	1000	750	110	
51102230BJ	51112230BJ	10	1000	750	110	
51102230BK	51112230BK	11	1200	750	110	
51102230BL	51112230BL	12	1200	750	110	

Versione con circolatore a tre velocità (solo per paesi extra CEE)  
Version with 3 speed pump (only for extra CEE country)  
Ausführung mit 3-Gang-Pumpe (nur für Klein CEE-Land)  
Version avec pompe à 3 vitesses (uniquement pour les pays extra CEE)  
Версия с трехскоростным насосом (только для стран, не входящих в ЕС)

Cod. Sx/Left	Cod. Dx/Right	Vie/Ways	L(mm)	H(mm)	P(mm)	€
51101230BA	51111230BA	2	600	750	110	
51101230BB	51111230BB	3	700	750	110	
51101230BC	51111230BC	4	700	750	110	
51101230BD	51111230BD	5	850	750	110	
51101230BE	51111230BE	6	850	750	110	
51101230BF	51111230BF	7	850	750	110	
51101230BG	51111230BG	8	1000	750	110	
51101230BH	51111230BH	9	1000	750	110	
51101230BJ	51111230BJ	10	1000	750	110	
51101230BK	51111230BK	11	1200	750	110	
51101230BL	51111230BL	12	1200	750	110	

Versione senza circolatore (con tronchetto spaziatore)  
Version without pump (with pipes pre-mounted)  
Ausführung ohne Pumpe (mit Balken vormontiert)  
Version sans pompe (avec des tuyaux pré-monté)  
Версия без насоса (с предустановленными трубами)



## IVR MULTIKLIMA 509/A



Interasse attacco tubazioni: 200 mm.  
 Pipe connection center hole distance: 200 mm.  
 Abstand des Rohranschlusses: 200 mm.  
 Entraxe des fixations: 200 mm.  
 Межосевое соединение : 200 мм.

Modulo di distribuzione con collettori in acciaio inox AISI 304 da 1" x 3/4" EK. Preassemblato in cassetta metallica verniciata RAL 9010, collettori completi di valvole termostattizzabili (per testa termoelettrica), rubinetto orientabile di carico scarico, valvola sfiato aria, valvole a sfera d'intercettazione, tappi e zanche. Versione con detentori micrometrici di regolazione

Water distribution cabinet includes: AISI 304 stainless steel manifolds 1" x 3/4" EK. Pre-assembled in RAL9010 plated metal cabinet, manifolds are fitted with thermostatic valves (for thermoelectric head), rotatable fill & drain valve, air vent, interception valves, caps and mounting brackets. Version with micrometric regulating lockshield

Verteilermodul mit Verteilern aus rostfreiem Stahl AISI 304 mit EK Übergang 1"x3/4". Vormontiert in einem lackiertem Metallkasten RAL 9010, Verteiler ausgestattet mit: thermostatisierbaren Ventilen (für den thermoelektrischen Kopf), dreheinstellbarem Füll- und Entleerungshahn, Luftablassventil, Absperrkugelhähnen, Kappen und Befestigungsklammern. Ausführung mit mikrometrisches Absperrventil zur Einstellung

Module de distribution avec collecteurs en acier inoxydable AISI 304, 1"x3/4" EK. Préassemblé dans un boîtier métallique verni RAL 9010, collecteurs pourvus de vanne thermostatisables (pour la tête thermoelectrique), robinet orientable de chargement/déchargement, vanne de purge de l'air, vannes d'arrêt, bouchons et plaque d'ancrage. Version avec coudes de réglages micrométriques de réglage

Распределительный модуль с коллекторами из нержавеющей стали AISI 304 1" x 3/4" Евроконус. Собранный коллекторный модуль вмонтирован в металлический шкаф, окрашенный RAL 9010. Состоит из: термостатических клапанов(для термостатических головок), дренажного клапана, воздушного клапана, шаровых кранов, заглушек и креплений. Данная версия с отсекающими микрометрическими клапанами.

Cod. Sx/Left	Cod. Dx/Right	Vie/Ways	L(mm)	H(mm)	P(mm)	€
50900200AA	50910200AA	2	400	630	90	
50900200AB	50910200AB	3	500	630	90	
50900200AC	50910200AC	4	500	630	90	
50900200AD	50910200AD	5	600	630	90	
50900200AE	50910200AE	6	600	630	90	
50900200AF	50910200AF	7	700	630	90	
50900200AG	50910200AG	8	700	630	90	
50900200AH	50910200AH	9	850	630	90	
50900200AJ	50910200AJ	10	850	630	90	
50900200AK	50910200AK	11	850	630	90	
50900200AL	50910200AL	12	1000	630	90	

## IVR MULTIKLIMA 509/B



Interasse attacco tubazioni: 200 mm.  
 Pipe connection center hole distance: 200 mm.  
 Abstand des Rohranschlusses: 200 mm.  
 Entraxe des fixations: 200 mm.  
 Межосевое соединение : 200 мм.

Modulo di distribuzione con collettori in acciaio inox AISI 304 da 1" x 3/4" EK. Preassemblato in cassetta metallica verniciata RAL 9010, collettori completi di valvole termostattizzabili (per testa termoelettrica), rubinetto orientabile di carico scarico, valvola sfiato aria, valvole a sfera d'intercettazione, tappi e zanche. Versione con misuratori di portata

Water distribution cabinet includes: AISI 304 stainless steel manifolds 1" x 3/4" EK. Pre-assembled in RAL9010 plated metal cabinet, manifolds are fitted with thermostatic valves (for thermoelectric head), rotatable fill & drain valve, air vent, interception valves, caps and mounting brackets. Version with flowmeter

Verteilermodul mit Verteilern aus rostfreiem Stahl AISI 304 mit EK Übergang 1"x3/4". Vormontiert in einem lackiertem Metallkasten RAL 9010, Verteiler ausgestattet mit: thermostatisierbaren Ventilen (für den thermoelektrischen Kopf), dreheinstellbarem Füll- und Entleerungshahn, Luftablassventil, Absperrkugelhähnen, Kappen und Befestigungsklammern. Ausführung mit Durchflussmesser

Module de distribution avec collecteurs en acier inoxydable AISI 304, 1"x3/4" EK. Préassemblé dans un boîtier métallique verni RAL 9010, collecteurs pourvus de vanne thermostatisables (pour la tête thermoelectrique), robinet orientable de chargement/déchargement, vanne de purge de l'air, vannes d'arrêt, bouchons et plaque d'ancrage. Version avec mesureurs de débit

Распределительный модуль с коллекторами из нержавеющей стали AISI 304 1" x 3/4" Евроконус. Собранный коллекторный модуль вмонтирован в металлический шкаф, окрашенный RAL 9010. Состоит из: термостатических клапанов(для термостатических головок), дренажного клапана, воздушного клапана, шаровых кранов, заглушек и креплений. Данная версия с расходомерами

Cod. Sx/Left	Cod. Dx/Right	Vie/Ways	L(mm)	H(mm)	P(mm)	€
50900200BA	50910200BA	2	400	630	90	
50900200BB	50910200BB	3	500	630	90	
50900200BC	50910200BC	4	500	630	90	
50900200BD	50910200BD	5	600	630	90	
50900200BE	50910200BE	6	600	630	90	
50900200BF	50910200BF	7	700	630	90	
50900200BG	50910200BG	8	700	630	90	
50900200BH	50910200BH	9	850	630	90	
50900200BJ	50910200BJ	10	850	630	90	
50900200BK	50910200BK	11	850	630	90	
50900200BL	50910200BL	12	1000	630	90	

## IVR MULTIKLIMA

### Gruppi di miscelazione / Mixing units



### IVR 711



**IVR 711/A**  
Circolatore classe "A"  
RS25/6-RKA M Wilo  
Cod. 171115007



**IVR 711/C**  
Circolatore a 3 velocità  
NYL33-25 P Salmson  
Cod. 171115001



**IVR 711/S**  
Senza Circolatore  
Cod. 171115000

Gruppo di miscelazione a punto fisso con testa termostatica  
Fixed point mixing unit with thermostatic head  
Fest eingestellte Mischgruppe mit Thermostatkopf  
Groupe de mélange à point fixe avec tête thermostatique  
Смесительная группа с фиксированной точкой и термостатической головкой IVR.

Cod./Code	Misura/Size	□/田	€
171115007	3/4" x 1"	1	
171115001	3/4" x 1"	1	
171115000	3/4" x 1"	1	

### IVR 712



**IVR 712/A**  
Circolatore classe "A"  
RS25/6-RKA M Wilo  
Cod. 171215007



**IVR 712/C**  
Circolatore a 3 velocità  
NYL33-25 P Salmson  
Cod. 171215001



**IVR 712/S**  
Senza Circolatore  
Cod. 171215000

Gruppo di miscelazione a punto fisso con miscelatore termostatico  
Fixed point mixing unit with thermostatic mixing valve  
Fest eingestellte Mischgruppe mit thermostatmischer Mischer  
Groupe de mélange à point fixe avec mitigeur thermostatique  
Смесительная группа с фиксированной точкой и термостатическим смесителем.

Cod./Code	Misura/Size	□/田	€
171215007	3/4" x 1"	1	
171215001	3/4" x 1"	1	
171215000	3/4" x 1"	1	

### IVR 713



**IVR 713/A**  
Circolatore classe "A"  
RS25/6-RKA M Wilo  
Cod. 171315007



**IVR 713/C**  
Circolatore a 3 velocità  
NYL33-25 P Salmson  
Cod. 171315001



**IVR 713/S**  
Senza Circolatore  
Cod. 171315000

Gruppo di miscelazione modulante con servocomando elettronico  
Modulating mixing unit with electronic actuator  
Modulierende Mischgruppe mit elektrothermischer Servosteuerung  
Groupe de mélange modulant avec servocommande électrothermique  
Смесительная группа с электротермическим приводом.

Cod./Code	Misura/Size	□/田	€
171315007	3/4" x 1"	1	
171315001	3/4" x 1"	1	
171315000	3/4" x 1"	1	



## IVR 714

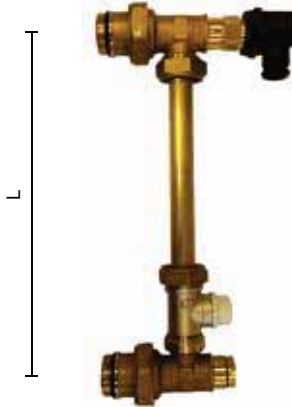

Gruppo by-pass con valvola di regolazione micrometrica e termostato di sicurezza (taratura 50° C)  
 By-pass unit with micrometric regulating valve and safety thermostat (set at 50° C).  
 Bypass-Gruppe mit mikrometrischem Einstellventil und Sicherheitsthermostat (eingestellt um 50°)  
 Groupe by-pass avec vanne de réglage micrométrique et thermostat de sécurité (réglé à 50° C)  
 Группа бай-пасс с регулирующим микрометрическим клапаном и предохранительным термостатом(калибровка 50° C)

Cod./Code	Misura/Size	L	□/田	€
171410501	1"	277	1	

Senza termostato di sicurezza  
 Without safety thermostat

Cod./Code	Misura/Size	L	□/田	€
171410502	1"	277	1	

## IVR 714/R



Raccordo 3 pezzi postasonda per gruppi di miscela IVR 711  
 Three-piece sensor connection for mixing units IVR 711  
 Dreiteiliger Anschluss für Mischergruppen IVR 711  
 Raccord à trois pièces pour groupes de mélange IVR 711  
 Трехсоставной фитинг для смесительной группы IVR 711

Cod./Code	Misura/Size	□/田	€
171431001	1"	8/48	

## IVR 330



Separatore idraulico in acciaio inox aisi 304 completo di raccordi  
 Hydraulic separator in stainless steel AISI 304 with unions  
 Hydraulische Weiche aus rostfreiem Stahl AISI 304 mit Anschlüssen  
 Séparateur hydraulique en acier inoxydable AISI 304 avec raccords  
 Гидравлический сепаратор из нержавеющей стали AISI 304 в комплекте с фитингами

Cod./Code	Misura/Size	□/田	€
133027701	1" M x 1" F	1/1	

## IVR 330/C



Guscio di coibentazione per separatore idraulico  
 Isolation for hydraulic separator  
 Isolierung für hydraulische Weiche  
 Isolation pour le séparateur hydraulique  
 Изоляция для гидравлического сепаратора

Cod./Code	Misura/Size	□/田	€
335800420		1/1	

## IVR 591 - TESTA TERMOSTATICA SUNNY SONDA IMMERSIONE



Testa termostatica con sensore a liquido a bassa inerzia termica - con sonda ad immersione  
Thermostatic head with liquid sensor at low thermal inertia - with sensor immersion sleeve  
Thermostatkopf mit Flüssigkeitssensor mit geringer thermischen Trägheit - mit Tauchsonde  
Tête thermostatique avec capteur à liquide à faible inertie thermique - avec sonde à immersion  
Термостатическая головка с жидкостным сенсором, низкой термоинерцией и погружным датчиком

Cod./Code	Misura/Size	□/田	€
159110001	M30 x 1,5	1/20	

## IVR 331 - SERVOCOMANDO 0-10 24V NC



Servocomando 0-10 24V NC  
Actuator 0-10 24 V NC (normally closed position)  
Servosteuerung 0-10 24V (normalerweise geschlossen)  
Servocommande 0-10 24V (normalement fermé)  
Сервопривод 0-10 24V NC (нормально закрытый)

Cod./Code	Misura/Size	□/田	€
1331AXS122	M30 x 1,5	4/16	

## IVR 332 - TERMOSTATO DI SICUREZZA



Termostato di sicurezza  
Safety thermostat  
Sicherheitsthermostat  
Thermostat de sécurité  
Предохранительный термостат

Cod./Code	Misura/Size	T°	□/田	€
133205640	1/2"	40°	8/120	
133205650	1/2"	50°	8/120	

## COLLETTORI / MANIFOLDS

Collettori Inox / Inox Manifolds  
GLOBO

### IVR 982/A - 982/B



Valvola a sfera a passaggio totale con bocchettone - attacchi M/F, sede conica, con autotenuta  
Full bore ball valve with tail piece - M/F, with conical seat and auto-sealing  
Kugelhahn mit vollem Durchgang und Rohrverschraubung - AG/IG, mit Kugelsitz und Selbstdichtung  
Vanne à boisseau sphérique à passage intégral avec raccord - M/F, avec siège conique et auto-étanche  
Полнопроходной шаровой кран со сгоном и накидной гайкой - соединения Н/В, с коническим седлом и герметичной прокладкой

Cod./Code	Misura/Size	□/田	€
198207108	3/4" x 1" Red	10/60	
198207111	3/4" x 1" Blue	10/60	
198210108	1" x 1" Red	10/40	
198210111	1" x 1" Blue	10/40	

### IVR 206/A - 206/B



Valvola a sfera a passaggio totale con dado folle - attacchi F/F, sede conica  
Full bore ball valve with crazy nut - F/F, with conical seat  
Kugelhahn mit vollem Durchgang und verrückter Nuss - IG/IG, mit Kugelsitz  
Vanne à boisseau sphérique à passage intégral avec écrou fou - F/F, avec siège conique  
Полнопроходной шаровой кран с накидной гайкой - соединения В/В, с коническим седлом

Cod./Code	Misura/Size	□/田	€
120605108	1/2" x 3/4" Red	10/60	
120605111	1/2" x 3/4" Blue	10/60	
120607078	3/4" x 3/4" Red	10/60	
120607081	3/4" x 3/4" Blue	10/60	
120607208	3/4" x 1" Red	10/40	
120607211	3/4" x 1" Blue	10/40	

Cod./Code	Misura/Size	□/田	€
196410008	1" x 1" Red	10/40	
196410211	1" x 1" Blue	10/40	

### IVR 205/A - 205/B



Valvola a sfera a passaggio totale con dado folle - attacchi M/F - sede piana  
Full bore ball valve with crazy nut - M/F, with flat seat  
Kugelhahn mit vollem Durchgang und verrückter Nuss - AG/IG, mit Flachsitz  
Vanne à boisseau sphérique à passage intégral avec écrou fou - M/F, avec siège plate  
Полнопроходной шаровой кран с накидной гайкой - соединения Н/В, с плоским седлом

Cod./Code	Misura/Size	□/田	€
120505077	1/2" x 3/4" RED	10/40	
120505211	1/2" x 3/4" BLU	10/40	
120507208	3/4" x 1" RED	10/40	
120507211	3/4" x 1" BLU	10/40	



## IVR 980/A - 980/B



Valvola a sfera a passaggio totale con bocchettone - attacchi M/F, sede conica, con autotenuta  
Full bore ball valve with tail piece - M/F, with conical seat and auto-sealing  
Kugelhahn mit vollem Durchgang und Rohrverschraubung - AG/IG, mit Kugelsitz und Selbstdichtung  
Vanne à boisseau sphérique à passage intégral avec raccord - M/F, avec siège conique et auto-étanche  
Полнопроходной шаровой кран со сгоном и накидной гайкой - соединения Н/В, с коническим седлом и герметичной прокладкой

Cod./Code	Misura/Size	□/田	€
198010008	1" x 1" Red	10/40	
198010211	1" Blue	10/40	
198012008	1"1/4 x 1"1/4 Red	10/40	
198012211	1"1/4 x 1"1/4 Blue	10/40	

- NOTA: DISPONIBILE CON FILETTATURA NPT: ultime due cifre del codice sono "16"
- NOTE: AVAILABLE WITH THREADED END NPT: last two digits of code is "16"
- ANMERKUNG: ERHÄLTICH MIT NPT-GEWINDE: die letzten beiden Ziffern der Artikelnummer sind "16"
- NOTE: DISPONIBLE AVEC FILETAGE NPT: les deux derniers chiffres du code sont "16"
- ПРИМЕЧАНИЕ: ДОСТУПНО С РЕЗЬБОЙ NPT: две последние цифры кода "16"

## IVR 981/A - 981/B



Valvola a sfera a passaggio totale a squadra con bocchettone - attacchi M/F, sede conica, con autotenuta  
Angle full bore ball valve with tail piece - M/F, with conical seat and auto-sealing  
Kugelhahn mit vollem Durchgang, eckförmig, Rohrverschraubung - AG/IG, mit Kugelsitz und Selbstdichtung  
Vanne à boisseau sphérique à passage intégral à équerre avec raccord - M/F, avec siège conique et auto-étanche  
Полнопроходной угловой шаровой кран со сгоном и накидной гайкой - соединения Н/В, с коническим седлом и с герметичной прокладкой

Cod./Code	Misura/Size	□/田	€
198110008	1" Red	10/40	
198110211	1" Blue	10/40	

## IVR 827/A - IVR 827/B



Maniglia farfalla rossa - Maniglia farfalla blu, sede piana  
Red butterfly handle - Blue butterfly handle, flat seat  
Rot und/oder Blau Flügelgriff mit flachem Sitz  
Poignée papillon rouge - poignée papillon bleu avec siège plate  
Красная ручка-бабочка - Синяя ручка-бабочка, плоское седло.

Cod./Code	Misura/Size	□/田	€
182707002	Red 3/4" x 1"	10/60	
182707011	Blue 3/4" x 1"	10/60	

## COLLETTORI / MANIFOLDS

Collettori Inox / Inox Manifolds  
 GLOBO TERMOMETRO



Valvola a sfera M/F, attacco termometro, bocchettone autotenuta, nichelata. Per AVANT FLOOR

Ball valve M/F with thermometer, auto seal tailpiece, nickel plated. For AVANT FLOOR

Kugelhahn AG x IG mit Innen- und Außengewinde, Thermometeranschluss, selbstdichtendem Stutzen, vernickelt - für AVANT FLOOR

Vanne à boisseau sphérique M/F, fixation thermomètre, raccord autoétanche, nickelée - pour AVANT FLOOR

Шаровой никелированный кран с термометром, сгоном, самогерметизирующейся прокладкой, соединение - Н/В, для AVANT FLOOR

### IVR 979/A - 979/B



Maniglia farfalla rossa / blu e attacco sonda per temperatura. Sede conica

Red/blue butterfly handle and sensor connection. Conical seat

Roter/blauer Flügelgriff und Anschluss für Temperatursonde mit Kugelsitz.

Poignée papillon rouge/bleu et fixation sonde pour température

Красная/синяя ручка-бабочка и соединение для температурного зонда. С коническим седлом

Cod./Code	Misura/Size		□/田	€
197910008	1" x 1" Red	M10 x 1	10/40	
197910211	1" x 1" Blue	M10 x 1	10/40	

### IVR 820



Termometro con guaina completo per IVR 979/A - IVR 979/B

Thermometer with pocket for IVR 979/A - IVR 979/B

Thermometer mit Hülle für IVR 979/A - IVR 979/B

Thermomètre avec gaine complète pour IVR 978/A - IVR 978/B - IVR 979/A - IVR 979/B

Термометр с кожухом для IVR 979/A - IVR 979/B

Cod./Code	Misura/Size	□/田	€
182003001	3/8" - Øe 41	10/120	



Valvola a sfera a passaggio totale - con portasonda  
Full bore ball valve with sensor connection  
Kugelhahn mit vollem Durchgang mit Anschluss für Temperatursonde  
Vanne à sphère à passage total avec fixation sonde pour température  
Полнопроходной шаровой кран с соединением для датчика температуры

## IVR 954 S



Attacchi F/F  
Threaded ends F/F  
Alle IG/IG  
Fixations F/F  
Соединения - В/В

Cod./Code	Misura/Size		□/田	€
195405711	1/2"	M10 x 1	20/80	
195407711	3/4"	M10 x 1	12/48	
195410711	1"	M10 x 1	12/48	

## IVR 944/AS



Con bocchettone autotenuta. Sede conica M/F  
Auto seal tailpiece. Conical seat M/F  
Mit Selbstdichtung. Kegelsitz AG/IG  
Avec raccord avec auto-étanche M/F  
Со сгоном и самогерметизирующейся прокладкой. С коническим седлом Н/В

Cod./Code	Misura/Size		□/田	€
194407078	3/4" x 3/4"	M10 x 1	10/40	
194407108	3/4" x 1"	M10 x 1	10/40	
194410108	1" x 1"	M10 x 1	10/40	



## COLLETTORI / MANIFOLDS

Testa termoelettrica / Thermo-electric actuator

Testa termoelettrica fornita nella versione NC (normalmente chiusa) o NO (normalmente aperta) per AVANT FLOOR  
Thermo-electric actuator, version NC (normally closed position) or NO (normally open position) for AVANT FLOOR  
Thermoelektrischer Kopf, erhältlich in den Ausführungen NC (normalerweise geschlossen) - NO (normalerweise geöffnet) - für AVANT  
Tête thermoélectrique fournie dans la version NC (normalement fermée) - NO (normalement ouverte) AVANT FLOOR  
Термоэлектропривод, NC (нормально закрытый) или NO (нормально открытый) для AVANT FLOOR

### IVR 823



NC



NO

Testa termoelettrica fornita nella versione NC (normalmente chiusa) o NO (normalmente aperta) per AVANT FLOOR - 230 V

Thermo-electric actuator, version NC (normally closed position) or NO (normally open position) for AVANT FLOOR - 230 V

Thermoelektrischer Kopf, erhältlich in den Ausführungen NC (normalerweise geschlossen) - NO (normalerweise geöffnet) - für AVANT FLOOR 230 V

Tête thermoélectrique fournie dans la version NC (normalement fermée) - NO (normalement ouverte) AVANT FLOOR - 230 V

Термоэлектропривод, NC (нормально закрытый) или NO (нормально открытый) для коллекторов AVANT FLOOR - 230 V

Cod./Code	Misura/Size	□/田	€
182300101	230V NC	1/10	
182300110	230V NO	1/10	

Con microinterruttore ausiliario / With auxiliary microswitch / Mit Mikroschalter  
Avec contact auxiliaire / С дополнительным микро-переключателем

Cod./Code	Misura/Size	□/田	€
182300140	230V NC	1/10	

### IVR 824



NC



NO

Testa termoelettrica fornita nella versione NC (normalmente chiusa) o NO (normalmente aperta) per AVANT FLOOR - 24 V

Thermo-electric actuator, version NC (normally closed position) or NO (normally open position) for AVANT FLOOR - 24 V

Thermoelektrischer Kopf, erhältlich in den Ausführungen NC (normalerweise geschlossen) - NO (normalerweise geöffnet) - für AVANT FLOOR - 24 V

Tête thermoélectrique fournie dans la version NC (normalement fermée) - NO (normalement ouverte) AVANT FLOOR - 24 V

Термоэлектропривод, NC (нормально закрытый) или NO (нормально открытый) для коллекторов AVANT FLOOR - 24 V

Cod./Code	Misura/Size	□/田	€
182400101	24V NC	1/10	
182400110	24V NO	1/10	

Con microinterruttore ausiliario / With auxiliary microswitch / Mit Hilfs-Mikroschalter  
Avec contact auxiliaire / С дополнительным микро-переключателем

Cod./Code	Misura/Size	□/田	€
182400140	24V NC	1/10	



## COLLETTORI / MANIFOLDS

Collettori Inox / Inox Manifolds  
AVANT ACCESSORIES

Accessori per AVANT FLOOR  
Accessories for AVANT FLOOR  
Zubehöre für AVANT FLOOR  
accessoire pour AVANT FLOOR  
аксессуары для коллектора AVANT FLOOR

### IVR 825



Termostato ambiente a parete 230 V  
Room thermostat 230 V  
Raumthermostat als Wandausführung 230 V  
Thermostat ambient mural 230 V  
Настенный термостат для жилых помещений 230 V

Cod./Code	Misura/Size	□/田	€
182500001	230V	1	

### IVR 821

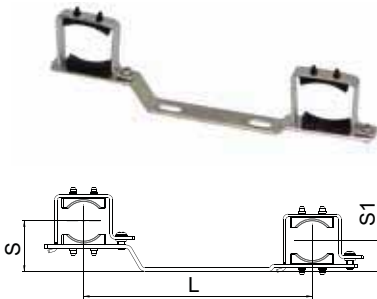

Set di 2 zanche doppie di fissaggio antivibrazione per AVANT FLOOR  
Set of 2 double insulated vibration-free mounting bracket for AVANT FLOOR  
Garnitur mit 2 doppelten schwingungsdämpfenden Befestigungsklammern für AVANT FLOOR  
Kit de 2 doubles plaques d'ancrage antivibration pour AVANT FLOOR  
Комплект из двух двойных антивибрационных кронштейнов для AVANT FLOOR

Cod./Code	Misura/Size	S(mm)	L(mm)	S1(mm)	□/田	€
182100030	1"	44	200	27	2	
182100032	1"1/4	49	200	32	2	

### IVR 840

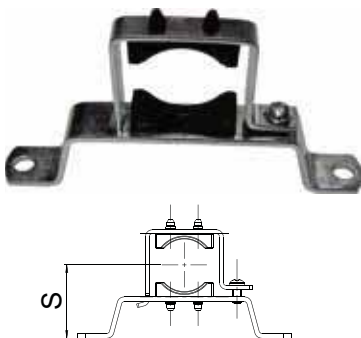

Set di 2 zanche singole di fissaggio antivibrazione per AVANT FLOOR  
Set of 2 single insulating vibration-free mounting bracket for AVANT FLOOR  
Garnitur mit 2 einzigen schwingungsdämpfenden Befestigungsklammern für AVANT FLOOR  
Kit de 2 plaques simples d'ancrage antivibration pour AVANT FLOOR  
Комплект из двух отдельных антивибрационных кронштейнов для AVANT FLOOR

Cod./Code	Misura/Size	S(mm)	L(mm)	S1(mm)	□/田	€
184010050	1"	48			2	
184012050	1"1/4	50			2	

Cod./Code	Misura/Size	S(mm)	L(mm)	S1(mm)	□/田	€
184010052	1"	83			2	
184012052	1"1/4	85			2	

## IVR 404



Raccordo sdoppiatore Y per AVANT FLOOR  
 Y junction splitter for AVANT FLOOR  
 Y-Verteiler Splitter für AVANT FLOOR  
 Y jonction séparateur pour AVANT FLOOR  
 Y - разделитель потока для AVANT FLOOR

Cod./Code	Misura/Size	Attacco/Connection	□/田	€
140407001	3/4" EK	3/4" EK	10/40	

## IVR 408 K



Per IVR 802 - IVR 804  
 For IVR 802 - IVR 804  
**IVR 408/1 K**



Per IVR 803 - IVR 805  
 For IVR 803 - IVR 805  
**IVR 408/2 K**



Per IVR 800 - IVR 806  
 For IVR 800 - IVR 806  
**IVR 408/3 K**



Per IVR 801 - IVR 807  
 For IVR 801 - IVR 807  
**IVR 408/4 K**



Per tutti i collettori AVANT FLOOR/  
 For all AVANT FLOOR manifolds  
**IVR 408/5 K**



Per tutti i collettori AVANT FLOOR/  
 For all AVANT FLOOR manifolds  
**IVR 408/6 K**



Per tutti i collettori AVANT FLOOR/  
 For all AVANT FLOOR manifolds  
**IVR 408/7 K**

Kit estensione per AVANT FLOOR  
 Extension Kit for AVANT FLOOR  
 Extension Kit für AVANT FLOOR  
 Kit d'extension pour AVANT FLOOR  
 Дополнительный комплект для AVANT FLOOR

Cod./Code	Modello/Model AvantFloor	Vie/Ways	Misura/Size	□/田	€
140820571	IVR 408/1 K	1	1"	1	
140820576	IVR 408/2 K	1	1"	1	
140820580	IVR 408/3 K	1	1"	1	
140820581	IVR 408/4 K	1	1"	1	
140820590	IVR 408/5 K	1	1"	1	
140820591	IVR 408/6 K	1	1"	1	
140820592	IVR 408/7 K	1	1"	1	

## IVR 822



Etichette autoadesive  
 Stickers  
 Klebeetiketten  
 Étiquettes autocollantes  
 Стикеры

Cod./Code	Tipo/Type	□/田	€
182200001	IVR 822	100/120	

## IVR 847 A



Guscio isolante aperto 12 uscite superiori ed inferiori per AVANT FLOOR  
Open insulating shell with upper and lower 12 ways for AVANT FLOOR  
Geöffnete Isolierhülse mit 12 oberen und unteren Ausgängen für Verteiler AVANT FLOOR  
Coque isolante ouverte pour 12 sorties inférieures et supérieures pour AVANT FLOOR  
Изоляция 12 верхних и нижних выходов для коллекторов AVANT FLOOR

Cod./Code	Misura/Size	□/田	€
1847A1012	1"	10	
1847A1212	1"1/4	10	

## IVR 847 C



Guscio isolante chiuso 12 uscite inferiori per AVANT FLOOR  
Closed insulating shell with 12 lower ways for AVANT FLOOR  
Geschlossene Isolierhülse mit 12 unteren Ausgängen für Verteiler AVANT FLOOR  
Coque isolante "fermée" pour 12 sorties inférieures pour AVANT FLOOR  
Изоляция "Закрытая" 12 нижних выходов для коллекторов AVANT FLOOR

Cod./Code	Misura/Size	□/田	€
1847C1012	1"	10	
1847C1212	1"1/4	10	

## IVR 897



Termometro a contatto per AVANT FLOOR  
Contact thermometer for AVANT FLOOR  
Kontaktthermometer für AVANT FLOOR  
Thermomètre à contact pour AVANT FLOOR  
Контактный термометр для коллекторов AVANT FLOOR

Cod./Code	Øe	□/田	€
189700010	40	10/120	

## COLLETTORI / MANIFOLDS

### Collettori Industriali / Industrial Manifolds

#### IVR INOX

Collettore Industriale in acciaio inox AISI 304 1"1/2 - 2", interasse 70 mm., rubinetto carico/scarico acqua (adattatore da 1"), trattamento di elettrolucidatura

Stainless steel AISI 304 Industrial Manifold 1"1/2 - 2", center hole distance 70 mm., draining valve (adapter connection 1"), electro-polished treatment

Industrie-Verteiler aus rostfreiem Edelstahl AISI 304 1"1/2"- 2" - Abstand 70 mm. Füll-Entleerungshahn (1" Zwischenstück / Adapter), Elektropoliturbehandlung

Collecteur Industriel en acier inox AISI 304 1"1/2 - 2", avec vanne à boisseau sphérique de sectionnement (adaptateur 1") robinet purge et chargement, traitement d'électropolissage

Индустриальный коллектор из нержавеющей стали AISI 304, диаметр 1"1/2 - 2", межосевое расстояние 70мм, дренажный кран (адаптер 1"), электрополировка

## IVR 882

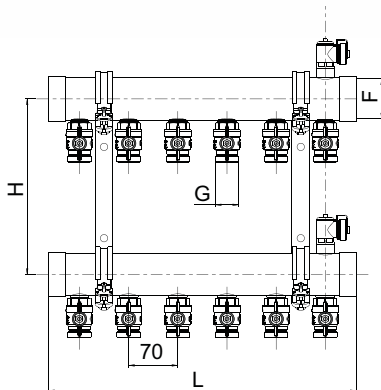
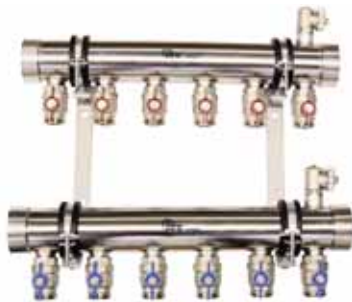

Con valvola a sfera d'intercettazione

With interception valve

Mit Absperrventil

Avec vanne à boisseau sphérique de sectionnement

С шаровым краном перехвата

Cod./Code	(F) Misura/Size	(G) Attacco/Connection	Vie/Ways	L(mm)	H(mm)	□/田	€
188242704	1"1/2	1"	4	291	250	1	
188242705	1"1/2	1"	5	361	250	1	
188242706	1"1/2	1"	6	431	250	1	
188242707	1"1/2	1"	7	501	250	1	
188242708	1"1/2	1"	8	571	250	1	
188242709	1"1/2	1"	9	641	250	1	
188242710	1"1/2	1"	10	711	250	1	
188242711	1"1/2	1"	11	781	250	1	
188242712	1"1/2	1"	12	851	250	1	
188242713	1"1/2	1"	13	921	250	1	
188242714	1"1/2	1"	14	991	250	1	
188252704	2"	1"	4	299	250	1	
188252705	2"	1"	5	369	250	1	
188252706	2"	1"	6	439	250	1	
188252707	2"	1"	7	509	250	1	
188252708	2"	1"	8	579	250	1	
188252709	2"	1"	9	649	250	1	
188252710	2"	1"	10	719	250	1	
188252711	2"	1"	11	789	250	1	
188252712	2"	1"	12	859	250	1	
188252713	2"	1"	13	929	250	1	
188252714	2"	1"	14	999	250	1	

## IVR 883

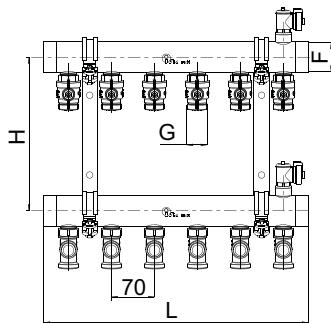

Con valvola a sfera d'intercettazione e detentore micrometrico  
With interception valve and micrometric lockshield  
Mit Absperrventil und mikrometrischer Rücklaufverschraubung  
Avec vanne à boisseau sphérique de sectionnement et coude de réglage micrométriques  
С шаровым краном перехвата

Cod./Code	(F) Misura/Size	(G) Attacco/Connection	Vie/Ways	L(mm)	H(mm)	□/田	€
188342704	1"1/2	1"	4	291	250	1	
188342705	1"1/2	1"	5	361	250	1	
188342706	1"1/2	1"	6	431	250	1	
188342707	1"1/2	1"	7	501	250	1	
188342708	1"1/2	1"	8	571	250	1	
188342709	1"1/2	1"	9	641	250	1	
188342710	1"1/2	1"	10	711	250	1	
188342711	1"1/2	1"	11	781	250	1	
188342712	1"1/2	1"	12	851	250	1	
188342713	1"1/2	1"	13	921	250	1	
188342714	1"1/2	1"	14	991	250	1	
188352704	2"	1"	4	299	250	1	
188352705	2"	1"	5	369	250	1	
188352706	2"	1"	6	439	250	1	
188352707	2"	1"	7	509	250	1	
188352708	2"	1"	8	579	250	1	
188352709	2"	1"	9	649	250	1	
188352710	2"	1"	10	719	250	1	
188352711	2"	1"	11	789	250	1	
188352712	2"	1"	12	859	250	1	
188352713	2"	1"	13	929	250	1	
188352714	2"	1"	14	999	250	1	

## IVR 884

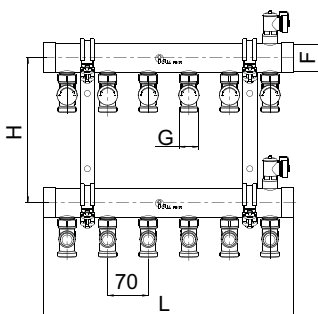

Con valvola termostattizzabile, cappello di regolazione, detentore micrometrico  
With thermostatic valve, operating plastic cap and micrometric lockshield  
Mit thermostatisierbarem Ventil, Einstellkappe und mikrometrischer Rücklaufverschraubung  
Avec vanne thermostatizable, chapeau de réglage et coude de réglage micrométrique  
С термостатическим клапаном, регулирующим колпачком и отсекающим клапаном

Cod./Code	(F) Misura/Size	(G) Attacco/Connection	Vie/Ways	L(mm)	H(mm)	□/田	€
188442704	1"1/2	1"	4	291	250	1	
188442705	1"1/2	1"	5	361	250	1	
188442706	1"1/2	1"	6	431	250	1	
188442707	1"1/2	1"	7	501	250	1	
188442708	1"1/2	1"	8	571	250	1	
188442709	1"1/2	1"	9	641	250	1	
188442710	1"1/2	1"	10	711	250	1	
188442711	1"1/2	1"	11	781	250	1	
188442712	1"1/2	1"	12	851	250	1	
188442713	1"1/2	1"	13	921	250	1	
188442714	1"1/2	1"	14	991	250	1	
188452704	2"	1"	4	299	250	1	
188452705	2"	1"	5	369	250	1	
188452706	2"	1"	6	439	250	1	
188452707	2"	1"	7	509	250	1	
188452708	2"	1"	8	579	250	1	
188452709	2"	1"	9	649	250	1	
188452710	2"	1"	10	719	250	1	
188452711	2"	1"	11	789	250	1	
188452712	2"	1"	12	859	250	1	
188452713	2"	1"	13	929	250	1	
188452714	2"	1"	14	999	250	1	



## COLLETTORI / MANIFOLDS

Collettori Industriali / Industrial Manifolds  
IVR INOX BASIC

### IVR 893

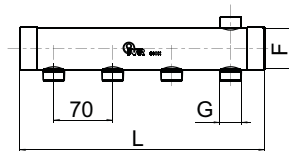

Collettore Industriale in acciaio inox AISI 304 1"1/2 - 2". interasse 70 mm., attacchi da 3/4", attacco per rubinetto carico/scarico, trattamento di elettrolucidatura

Stainless steel AISI 304 Industrial Manifold 1"1/2 - 2", outlet distance 70 mm, connections 3/4", draining valve connection, electropolished treatment

Industrie-Verteiler aus rostfreiem Edelstahl AISI 304 1"1/2 - 2" - Abstand 70 mm. Mit 3/4" Anschlüsse - Ein- und Ablassventil (1" Zwischenstück / Adapter), Elektropoliturbehandlung

Collecteur Industriel en acier inox AISI 304 1"1/2 - 2", entraxe 70mm, fixations de 3/4", traitement d'électropolissage

Индустриальный коллектор из нержавеющей стали AISI 304 1"1/2 - 2", выходы 3/4", межосевое расстояние 70мм, соединение для дренажного крана, электрополировка

Cod./Code	(F) Misura/Size	(G) Attacco/Connection	Vie/Ways	L(mm)	H(mm)	□/⊕	€
189342704	1"1/2	1"	4	291	5		
189342705	1"1/2	1"	5	361	1		
189342706	1"1/2	1"	6	431	1		
189342707	1"1/2	1"	7	501	1		
189342708	1"1/2	1"	8	571	1		
189342709	1"1/2	1"	9	641	1		
189342710	1"1/2	1"	10	711	1		
189342711	1"1/2	1"	11	781	1		
189342712	1"1/2	1"	12	851	1		
189342713	1"1/2	1"	13	921	1		
188342714	1"1/2	1"	14	991	1		
189352704	2"	1"	4	299	1		
189352705	2"	1"	5	369	1		
189352706	2"	1"	6	439	1		
189352707	2"	1"	7	509	1		
189352708	2"	1"	8	579	1		
189352709	2"	1"	9	649	1		
189352710	2"	1"	10	719	1		
189352711	2"	1"	11	789	1		
189352712	2"	1"	12	859	1		
189352713	2"	1"	13	929	1		
189352714	2"	1"	14	999	1		



## IVR 462

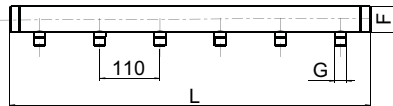

Collettore in acciaio inox AISI 304 da 1"1/2 - 2", con attacchi M/M da 1/2", interasse 110 mm; adatto per contatore acqua

Stainless steel AISI 304 Manifold 1"1/2 - 2" - connections M/M 1/2", center hole distance 110 mm; for water meter

Verteiler aus rostfreiem Stahl AISI 304 - 1"1/2 - 2" - alle Anschlüsse mit (AG x AG) Außengewinde 1/2", Abstand 110 mm; geeignet für Wasserzähler

Collecteur en acier inox AISI 304 de 1"1/2 - 2" - avec fixations M/M de 1/2", entraxe 110 mm pour compteur pour eau

Коллектор из нержавеющей стали AISI 304 1"1/2 - 2", выходы 1/2" Н/Н, межосевое расстояние 110 мм, для счетчиков воды

Cod./Code	(F) Misura/Size	(G) Attacco/Connection	Vie/Ways	L(mm)	□/田	€
146240502	1"1/2	1/2"	2	220	1	
146240503	1"1/2	1/2"	3	330	1	
146240504	1"1/2	1/2"	4	440	1	
146240505	1"1/2	1/2"	5	550	1	
146240506	1"1/2	1/2"	6	660	1	
146240507	1"1/2	1/2"	7	770	1	
146240508	1"1/2	1/2"	8	880	1	
146240509	1"1/2	1/2"	9	990	1	
146240510	1"1/2	1/2"	10	1100	1	
146250502	2"	1/2"	2	224	1	
146250503	2"	1/2"	3	334	1	
146250504	2"	1/2"	4	444	1	
146250505	2"	1/2"	5	554	1	
146250506	2"	1/2"	6	664	1	
146250507	2"	1/2"	7	774	1	
146250508	2"	1/2"	8	884	1	
146250509	2"	1/2"	9	994	1	
146250510	2"	1/2"	10	1104	1	

## IVR 463

**NEW**

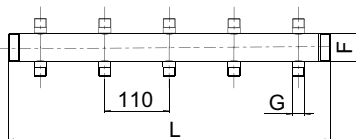

Collettore in acciaio inox AISI 304 da 1"1/2 - 2", con attacchi M/M da 1/2", interasse 110 mm; adatto per contatore acqua con attacchi contrapposti

Stainless steel AISI 304 manifold 1"1/2 - 2" - connections M/M 1/2", center hole distance 110 mm; for water meter with parallel connections

Verteiler aus rostfreiem Stahl AISI 304 - 1"1/2 - 2" - alle Anschlüsse AG/AG 1/2", Abstand 110 mm; geeignet für Wasserzähler mit Parallelanschlüssen

Collecteur en acier inox AISI 304 de 1"1/2 - 2" - avec fixations M/M de 1/2", entraxe 110 mm pour compteur pour eau avec fixations parallèles

Коллектор из нержавеющей стали AISI 304, диаметр 1"1/2 - 2", выходы 1/2" Н/Н, межосевое расстояние 110 мм, для счетчиков воды с противоположными соединениями

Cod./Code	(F) Misura/Size	(G) Attacco/Connection	Vie/Ways	L(mm)	□/田	€
146340503	1"1/2	1/2"	3	330	1	
146340504	1"1/2	1/2"	4	440	1	
146340505	1"1/2	1/2"	5	550	1	
146350503	2"	1/2"	3	334	1	
146350504	2"	1/2"	4	444	1	
146350505	2"	1/2"	5	554	1	

## COLLETTORI / MANIFOLDS

Collettori Industriali / Industrial Manifolds  
IVR INOX ACCESSORIES

Accessori per collettori IVR-INOX  
Accessories for manifolds IVR-INOX  
Zubehöre für Verteiler IVR-INOX  
Accessoires pour collecteurs IVR-INOX  
Аксессуары для коллекторов IVR-INOX

### IVR 86/A - IVR 86/B



Maniglia farfalla rossa - Maniglia farfalla blu, sede conica  
Red butterfly handle - Blue butterfly handle, conical seat  
Rot und/oder Blau Flügelgriff mit Kugelsitz  
Poignée papillon rouge - poignée papillon bleu avec siège conique  
Красная ручка-бабочка - Синяя ручка-бабочка, коническое седло

Cod./Code	Misura/Size	Attacco/Connection	□/田	€
108607102	Red 3/4"	1"	10/60	
108607104	Blue 3/4"	1"	10/60	

### IVR 551/C



Detentore dritto, attacco tubo ferro, senza bocchettone, nichelato. Per IVR-INOX  
Straight heavy lockshield, iron pipe connection, without tail piece, nickel plated. For IVR-INOX  
Gerade Rücklaufverschraubung für Eisenrohr, ohne Stutzen, vernickelt. Für IVR-INOX  
Coude droit, fixation tube fer, raccord autoétanche, nickelé. Pour IVR-INOX  
Прямой отсекающий клапан, соединение для стальной трубы, без муфты, никелированный. Для IVR-INOX

Cod./Code	Misura/Size	Attacco/Connection	□/田	€
155107010	3/4"	1"	10/120	

### IVR 566/C



Valvola termostatzabile dritta con cappello, attacco tubo ferro, senza bocchettone, nichelato. Per IVR-INOX  
Straight thermostatic valve with plastic cap, iron pipe connection, without tail piece, nickel plated. For IVR-INOX  
Thermostatventil mit gerader Verschraubung und Einstellkappe, ohne Stutzen, vernickelt. Für Verteiler IVR-INOX  
Vanne thermostatisable avec chapeau de réglage, fixation tube fer, sans raccord, nickelée. Pour IVR-INOX  
Прямой никелированный термостатический клапан с пластиковым колпачком, соединение для стальной трубы, без муфты. Для IVR-INOX

Cod./Code	Misura/Size	Attacco/Connection	□/田	€
156607010	3/4"	1"	10/60	

## IVR 406



Nipples in acciaio inox AISI 304. Per collettori IVR-INOX  
AISI 304 stainless steel nipples. For manifolds IVR-INOX  
Nippel aus rostfreiem Edelstahl AISI 304. Für Verteiler IVR-INOX  
Raccords autoétanche en acier AISI 304. Pour collecteurs IVR-INOX  
Ниппели из нержавеющей стали AISI 304. Для коллекторов IVR-INOX

Cod./Code	Misura/Size	□/⊕	€
140615001	1"1/2	10/120	
140620001	2"	10/60	

## IVR 416



Tappo M in acciaio inox AISI 304. Per IVR-INOX  
Stainless steel AISI 304 M plug. For IVR-INOX  
Deckel AG aus rostfreiem Stahl AISI 304. Für IVR-INOX  
Bouchon M en acier inox AISI 304. Pour IVR-INOX  
Заглушка из нержавеющей стали AISI 304 с наружной резьбой. Для коллекторов IVR-INOX

Cod./Code	Misura/Size	□/⊕	€
141615001	1"1/2	10/120	
141620001	2"	10/60	

## IVR 417



Tappo F in acciaio inox AISI 304. Per IVR-INOX 462  
Stainless steel AISI 304 F plug. For IVR-INOX 462  
Deckel IG aus rostfreiem Stahl AISI 304. Für IVR-INOX 462  
Bouchon F en acier inox AISI 304. Pour IVR-INOX 462  
Заглушка из нержавеющей стали AISI 304 с внутренней резьбой. Для IVR-INOX 462

Cod./Code	Misura/Size	□/⊕	€
141715001	1" 1/2	10/120	
141720001	2"	10/120	

## IVR 844

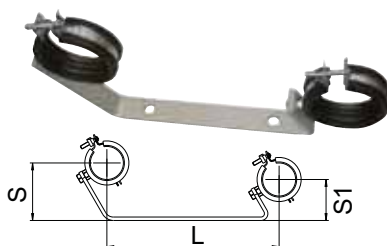

Zanca doppia per collettori. Per IVR-INOX  
Dual bracket for modular manifolds. For IVR-INOX  
Doppelklammern für Verteiler IVR-INOX  
Plaque d'ancrage double pour collecteurs. Pour IVR-INOX  
Двойной кронштейн для коллекторов IVR-INOX

Cod./Code	Misura/Size	S (mm)	L (mm)	S1 (mm)	□/⊕	€
184415001	1"1/2	83	250	59	2	
184420001	2"	87	250	63	2	

## IVR 847 I



Uscita zanca  
At the outlet  
Bei der Ausgang  
Près de la sortie  
Выход-кронштейн



Uscita intermedia  
In the middle  
In der Mitte  
Dans la moitié  
Промежуточный выход

Guscio isolante. Per IVR-INOX  
Isolating element. For IVR-INOX  
Isolierhülse. Für Verteiler IVR-INOX  
Coque isolante. Pour collecteurs IVR-INOX  
Изолирующий элемент. Для IVR-INOX

Cod./Code	Misura/Size	□/⊕	€
184715031	1"1/2 - iniziale zanca - 3 uscite	10	
184715032	1"1/2 - intermedio - 3 uscite	10	
184720031	2" - iniziale zanca - 3 uscite	10	
184720032	2" - intermedio - 3 uscite	10	

## COLLETTORI / MANIFOLDS

Collettori in ottone / Brass Manifolds  
**SUNNY FLOOR MODULAR**

Collettore componibile stampato in ottone interasse 38 mm M/F 3/4" - 1"; nichelato  
 Modular manifold forged brass, centre hole distance 38 mm M/F 3/4" - 1"; nickel-plated  
 Modularer Verteiler aus Pressmessing, Stützen-Abstand 38 mm, AG/IG 3/4" - 1"; vernickelt  
 Collecteur pré-assemblé en laiton Entraxe 38 mm M/F 3/4" - 1"; nickelé  
 Модульный никелированный коллектор из штампованной латуни. Соединение Н/В 3/4" - 1", межосевое расстояние 38 мм.

### IVR 872



Collettori con attacchi M 1/2"  
 M 1/2" connections  
 Anschlüsse AG 1/2"  
 Fixation M 1/2"  
 Коллекторы с соединениями Н 1/2"

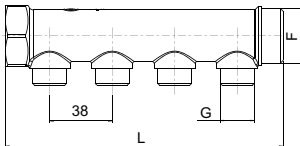

Cod./Code	(F) Misura/Size	(G) Attacco/Connection	Vie/Ways	L(mm)	□/田	€
187211302	3/4"	1/2"	2	90	10/60	
187211303	3/4"	1/2"	3	128	10/40	
187211304	3/4"	1/2"	4	166	10/40	
187221302	1"	1/2"	2	96	10/60	
187221303	1"	1/2"	3	131	10/40	
187221304	1"	1/2"	4	169	10/40	

### IVR 873



Collettori con attacchi M 24-19  
 M 24-19 connections  
 Anschlüsse AG M 24-19  
 Fixation M 24-19  
 Коллекторы с соединениями Н 24-19

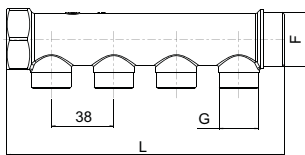

Cod./Code	(F) Misura/Size	(G) Attacco/Connection	Vie/Ways	L(mm)	□/田	€
187311302	3/4" x 18	24-19	2	90	10/60	
187311303	3/4" x 18	24-19	3	128	10/40	
187311304	3/4" x 18	24-19	4	166	10/40	
187321302	1" x 18	24-19	2	96	10/60	
187321303	1" x 18	24-19	3	131	10/40	
187321304	1" x 18	24-19	4	169	10/40	

### IVR 874



Collettori con attacchi F 1/2"  
 F 1/2" connections  
 Anschlüsse IG 1/2"  
 Fixation F 1/2"  
 Коллекторы с соединениями В 1/2"

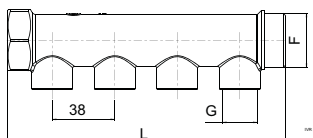

Cod./Code	(F) Misura/Size	(G) Attacco/Connection	Vie/Ways	L(mm)	□/田	€
187411302	3/4"	1/2"	2	90	10/60	
187411303	3/4"	1/2"	3	128	10/40	
187411304	3/4"	1/2"	4	166	10/40	
187421302	1"	1/2"	2	96	10/60	
187421303	1"	1/2"	3	131	10/40	
187421304	1"	1/2"	4	169	10/40	

## IVR 858

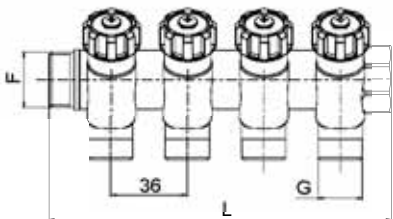

Collettori componibili stampati in ottone con rubinetti d'intercettazione - interasse 36 mm - M/F 3/4" - derivazioni M 1/2" - nichelato

Modular manifolds forged brass with stop cocks - outlet distance 36 mm - M/F 3/4" - with M 1/2" connection - nickel-plated

Modulare Verteiler aus Pressmessing mit Absperrventilen - Stützen-Abstand 36 mm - AG/IG 3/4" - Ableitung AG 1/2" - vernickelt

Collecteurs modulables estampés en laiton avec robinets de sectionnement - entraxe 36 mm - M/F 3/4" - Fixation M 1/2" - nickelé

Модульные никелированные коллекторы из штампованной латуни с запорными клапанами - межосевое расстояние 36мм - Н/В 3/4" - отводы Н 1/2"-никелированные

Cod./Code	(F) Misura/Size	(G) Attacco/Connection	Vie/Ways	L(mm)	□/田	€
185811202	3/4"	1/2"	2	92	10/60	
185811203	3/4"	1/2"	3	128	10/40	
185811204	3/4"	1/2"	4	164	10/40	

Collettori componibili stampati in ottone con rubinetti d'intercettazione - interasse 36 mm - M/F 1" - derivazioni M 1/2" - nichelato

Modular manifolds forged brass with stop cocks - outlet distance 36 mm - M/F 1" - with M 1/2" connection - nickel-plated

Modulare Verteiler, aus Pressmessing mit Absperrventilen - Abstand 36 mm - AG/IG 1" - Ableitung AG 1/2" - vernickelt

Collecteurs modulables estampés en laiton avec robinets de sectionnement - entraxe 36 mm - M/F 1" - fixation M 1/2" - nickelé

Модульные никелированные коллекторы из штампованной латуни с запорными клапанами - межосевое расстояние 36мм - Н/В 1" - отводы Н 1/2"-никелированные

Cod./Code	(F) Misura/Size	(G) Attacco/Connection	Vie/Ways	L(mm)	□/田	€
185821202	1"	1/2"	2	103	10/60	
185821203	1"	1/2"	3	139	10/40	
185821204	1"	1/2"	4	175	10/40	

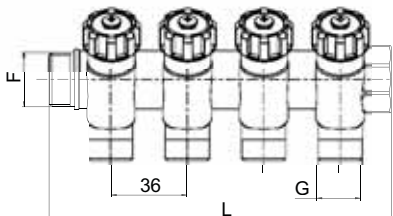

Collettori componibili stampati in ottone con rubinetti d'intercettazione - interasse 36 mm - M/F 3/4" - derivazioni M 24-19 - nichelato

Modular manifolds forged brass with stop cocks - outlet distance 36 mm - M/F 3/4" - with M 24-19 connection - nickel-plated

Modulare Verteiler, aus Pressmessing mit Absperrventilen - Stützen-Abstand 36 mm - AG/IG 3/4" - Ableitung AG 24-19 - vernickelt

Collecteurs modulables estampés en laiton avec robinets de sectionnement - entraxe 36 mm - M/F 3/4" - Fixations M 24-19 - nickelé

Модульные никелированные коллекторы из штампованной латуни с запорными клапанами - межосевое расстояние 36мм - Н/В 3/4"- отводы Н 24-19-никелированные

Cod./Code	(F) Misura/Size	(G) Attacco/Connection	Vie/Ways	L(mm)	□/田	€
185813202	3/4"	24-19	2	92	10/60	
185813203	3/4"	24-19	3	128	10/40	
185813204	3/4"	24-19	4	164	10/40	

Collettori componibili stampati in ottone con rubinetti d'intercettazione - interasse 36 mm - M/F 1" - derivazioni M 24-19 - nichelato

Modular manifolds forged brass with stop cocks - outlet distance 36 mm - M/F 1" - with M 24-19 connection - nickel-plated

Modulare Verteiler aus Pressmessing mit Absperrventilen - Stützen-Abstand 36 mm - IG/AG 1" - Ableitung AG 24-19 - vernickelt

Collecteurs modulables estampés en laiton avec robinets de sectionnement - entraxe 36 mm - M/F 1" - Fixations M 24-19 - nickelé

Модульные никелированные коллекторы из штампованной латуни с запорными клапанами - межосевое расстояние 36мм - Н/В 1" - отводы Н 24-19 - никелированные

Cod./Code	(F) Misura/Size	(G) Attacco/Connection	Vie/Ways	L(mm)	□/田	€
185823202	1"	24-19	2	103	10/60	
185823203	1"	24-19	3	139	10/40	
185823204	1"	24-19	4	175	10/40	



## COLLETTORI / MANIFOLDS ACCESSORI / ACCESSORIES

### IVR 580



Adattatori preassemblati per tubo rame - Nichelato  
Adapters preassembled for copper pipe - Nickel plated  
Vormontierter Adapter / Zwischenstücke für Kupferrohr - Vernickelt  
Adaptateurs préassemblés pour tubes en cuivre - Niklé  
Собранный адаптер для медной трубы - никелированный

Cod./Code	Misura/Size	Attacco/Connection	□/⊕	€
158005100	10	1/2"	20/200	
158005120	12	1/2"	20/400	
158005140	14	1/2"	20/200	
158005150	15	1/2"	20/400	
158005160	16	1/2"	20/400	
158024100	10	24-19	20/400	
158024120	12	24-19	20/400	
158024140	14	24-19	20/400	
158024150	15	24-19	20/400	
158024160	16	24-19	20/400	
158024180	18	24-19	20/400	
158007120	12	3/4" EK	20/400	
158007140	14	3/4" EK	20/400	
158007150	15	3/4" EK	20/400	
158007160	16	3/4" EK	20/400	
158007180	18	3/4" EK	20/400	

### IVR 581



Adattatori universali a compressione per tubi multistrato e polietilene reticolato PEX, nichelati - Nichelato  
Adapters for multilayer pipe and cross-linked polyethylene pipe PEX, nickel plated - Nickel plated  
Universal-Adaptern-Zwischenstücke für Mehrschichtrohren und aus vernetztem und vernickeltem Polyethylen PEX - vernickelt

Adaptateurs universels à compression pour tubes multicouche et polyéthylène réticulé PEX - nickelés - nichelés

Никелированные универсальные компрессионные адаптеры для металлопластиковых труб ,труб из сшитого полиэтилена PEX, никелированных труб

Cod./Code	Misura/Size	Attacco/Connection	□/⊕	€
158105143	14 x 2	1/2"	20/400	
158105156	15 x 2,5	1/2"	20/400	
158105163	16 x 2	1/2"	20/400	
158105164	16 x 2,25	1/2"	20/400	
158124143	14 x 2	24-19	20/400	
158124156	15 x 2,5	24-19	20/400	
158124163	16 x 2	24-19	20/400	
158124164	16 x 2,25	24-19	20/400	
158124173	17 x 2	24-19	20/400	
158124183	18 x 2	24-19	20/400	
158124203	20 x 2	24-19	20/400	
158107143	14 x 2	3/4" EK	20/400	
158107163	16 x 2	3/4" EK	20/300	
158107173	17 x 2	3/4" EK	20/300	
158107183	18 x 2	3/4" EK	20/300	
158107203	20 x 2	3/4" EK	20/300	
158110203	20 x 2	1"	10/150	
158110255	25 x 2,3	1"	10/150	
158110256	25 x 2,5	1"	10/150	
158110268	26 x 3	1"	10/80	

## IVR 830 CASSETTE METALLICHE



Armadio universale in acciaio zincato in lamiera preverniciata RAL 9010 per alloggiamento collettore. Include: base incasso, 2 kit guide regolabili, 2 piedini regolabili (regolazione consentita: da 0 a 100 mm), frontalino con rete elettrosaldata anche sul dorso per facilitare l'aggrappaggio dell'intonaco; porta e cornice in lamiera preverniciata RAL 9010 regolabile in profondità (regolazione consentita: da 0 a 50 mm)

Universal galvanised steel cabinet in pre-varnished sheet metal RAL 9010 designed to house the manifold. It includes: base for jointing, nr. 2 adjustable feet (allowed adjustment from 0 to 100mm), plastering and removal soaking front, net electrically welded to make plastering easier; door and frame in pre-varnished sheet metal RAL 9010 with adjustable depth (from 0 to 50 mm).

Universalschrank aus verzinktem rostfreiem Stahl aus lackierte Metallschicht RAL 9010 für Verteiler. Ausgestattet mit: Fuss für Montage, 2 Kits von verstellbaren Führungsschienen, 2 verstellbaren Füßchen (von 0 bis zum 100mm), elektrogeschweißtem Netz vorne und hinten zu einem guten Verputzen; Tur und Rahmen aus lackierter Metallschicht RAL 9010 mit verstellbarer Tiefe (von 0 bis zum 50 mm).

Armoire universel en acier galvanisé en tôle avec une couche de vernis RAL 9010 pour mettre le collecteur. Il inclut: la base pour le montage, 2 kits de coulisseaux réglables, 2 pieds réglables (de 0 à 100 mm), une grille électrosoudée arrière et derrière faciliter l'accrochage de l'enduit; porte et corniche en tôle avec une couche de vernis RAL 9010 avec la profondeur réglable (de 0 à 50 mm).

Универсальный шкаф из оцинкованной стали с полимерным покрытием RAL 9010 предназначен для монтажа коллекторов. Состоит из: основа для монтажа, 2 набора монтажных регулируемых реек, 2 регулируемые ножки (позволенная регулировка по высоте от 0 до 100мм), стенки шкафа и сетка для монтажа электросваривания, а также задняя панель для облегчения адгезии строительной штукатурки, выдвигающая рамка с дверцей окрашены RAL 9010 позволяет регулировать глубину установки (позволенная регулировка: от 0 до 50 мм)

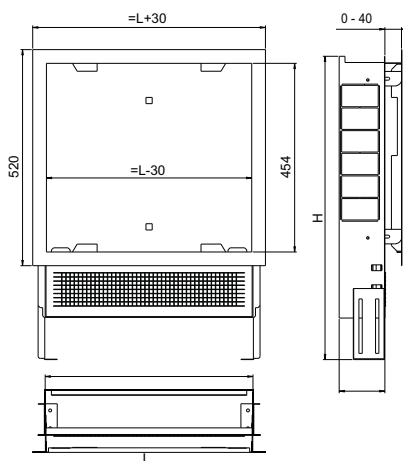

Cod./Code	L(mm)	H(mm)	P(mm)	MAX	□/田	€
1830040009	400	min. 630 max 730	90	3+3	1	
1830050009	500	min. 630 max 730	90	5+5	1	
1830060009	600	min. 630 max 730	90	7+7	1	
1830070009	700	min. 630 max 730	90	9+9	1	
1830085009	850	min. 630 max 730	90	12+12	1	
1830100009	1000	min. 630 max 730	90	13+13	1	
1830120009	1200	min. 630 max 730	90		1	
1830130009	1300	min. 630 max 730	90		1	
183004001	400	min. 630 max 730	110	3+3	1	
1830050011	500	min. 630 max 730	110	5+5	1	
183006001	600	min. 630 max 730	110	7+7	1	
183007001	700	min. 630 max 730	110	9+9	1	
1830085011	850	min. 630 max 730	110	12+12	1	
183010001	1000	min. 630 max 730	110	13+13	1	
183012001	1200	min. 630 max 730	110		1	
1830130011	1300	min. 630 max 730	110		1	
1830040015	400	min. 630 max 730	150	3+3	1	
1830050015	500	min. 630 max 730	150	5+5	1	
1830060015	600	min. 630 max 730	150	7+7	1	
1830070015	700	min. 630 max 730	150	9+9	1	
1830085015	850	min. 630 max 730	150	12+12	1	
1830100015	1000	min. 630 max 730	150	13+13	1	
1830120015	1200	min. 630 max 730	150		1	
1830130015	1300	min. 630 max 730	150		1	

## IVR 831 CASSETTE PLASTICHE



Cassetta in plastica universale per collettori, con set supporto collettori; per IVR 872-873-874

Plastic cabinet, with manifolds mounting set; for IVR 872-873-874

Universalgeläuse aus Plastik für Verteiler, mit Verteilerhalterungsset; für IVR 872-873-874

Cassette en plastique universelle pour collecteurs, avec set support collecteurs; pour IVR 872-873-874

Универсальный пластиковый шкаф с монтажным набором - для коллекторов IVR 872-873-874

Cod./Code	Misura/Size	MAX	□/田	€
183103201	320 x 265 x 80	4	1	
183104001	400 x 265 x 80	7	1	
183105001	500 x 265 x 80	9	1	
183106001	600 x 265 x 80	11	1	

## IVR 360 AIRVENT AUTO



Valvola automatica di sfogo aria Ø 42 sfogo aria superiore, nichelata  
 Automatic air-vent nickel-plated - Ø 42 top air-vent  
 Automatisches Entlüftungsventil vernickelt - Ø 42 - Entlüftung oben -  
 Vanne automatique purgeur d'air nickelée - Ø 42 vanne automatique de purge supérieure  
 Автоматический воздухоотводчик ,никелированный - Ø 42 - воздухоотвод вертикальный

Cod./Code	Misura/Size	□/田	€
136003001	3/8"	16/64	
136005001	1/2"	16/64	

## IVR 361



Valvola automatica di sfogo aria Ø 39 attacco laterale, nichelata  
 Automatic air-vent nickel-plated - Ø 39 side connection  
 Automatisches Entlüftungsventil vernickelt - Ø 39 - mit seitlichem Außenanschlussgewinde  
 Vanne automatique purgeur d'air nickelée - Ø 39 fixation lateral  
 Автоматический воздухоотводчик, никелированный - Ø 39 с боковым подключением

Cod./Code	Misura/Size	□/田	€
136103001	3/8"	10/80	
136105001	1/2"	10/60	

## IVR 816



Valvola automatica di sfogo aria, sfogo aria laterale, nichelata  
 Automatic air-vent, side air-vent, nickel-plated  
 Automatisches Entlüftungsventil vernickelt - Entlüftung seitlich  
 Vanne automatique purgeur d'air nickelée - purgeur d'air lateral  
 Автоматический воздухоотводчик никелированный - воздухоотвод боковой

Cod./Code	Misura/Size	□/田	€
181603001	3/8"	16/64	

## IVR 832



Valvola automatica di sfogo aria Ø 50 sfogo aria superiore, nichelata  
 Automatic air-vent, Ø 50 top air-vent, nickel-plated  
 Automatisches Entlüftungsventil vernickelt - Ø 50 - Entlüftung oben -  
 Vanne automatique purgeur d'air nickelée - Purge d'air Ø 50 supérieur  
 Автоматический воздухоотводчик никелированный - Ø 50 - воздухоотвод вертикальный

Cod./Code	Misura/Size	□/田	€
183203001	3/8"	10/60	
183205001	1/2"	10/60	

## IVR 364



Tappo per radiatori con valvola automatica di sfogo aria, nichelato  
Automatic air-vent for radiators, nickel-plated - Automatic / nickel-plated  
Entlüftungsventil für Heizkörper vernickelt - Automatisches Entlüftung  
Vanne purgeur d'air pour radiateur - automatique / nickelée  
Заглушка для радиаторов с никелированным автоматическим воздухоотводчиком

Cod./Code	Misura/Size	□/田	€
136410001	1" DX	10/90	
136410002	1" SX	10/90	
136412001	1"1/4 DX	10	
136412002	1"1/4 SX	10	

## IVR 367



Valvola sfogo aria per radiatori manuale, nichelata  
Automatic air-vent for radiators, Nickel-plated - Manual / Nickel-plated  
Entlüftungsventil für Heizkörper vernickelt, - Manuelles Entlüftung  
Vanne purgeur d'air pour radiateur - manuel / nickelée  
Воздухоотводчик для радиаторов , ручной , никелированный

Cod./Code	Misura/Size	□/田	€
136702001	1/4"	100/1200	
136703001	3/8"	100/1200	
136705001	1/2"	75/900	

## IVR 833



Valvola sfogo aria per radiatori manuale con tenuta P.T.F.E. nichelata  
Automatic air-vent for radiators, nickel-plated - Manual with P.T.F.E. seal  
Entlüftungsventil für Heizkörper vernickelt - Manuelles Entlüftung - mit P.T.F.E. - Dichtung  
Vanne purgeur d'air pour radiateur, nickelée - Vanne manuelle avec tenue en P.T.F.E.  
Воздухоотводчик для радиаторов, ручной, никелированный с уплотнением P.T.F.E.

Cod./Code	Misura/Size	□/田	€
183303001	3/8"	100/1200	
183305001	1/2"	50/600	

## IVR 837



Rubinetto d'intercettazione per valvola automatica di sfogo aria  
Interception valve for automatic air vent  
Absperrentil für automatisches Entlüftungsventil  
Robinet de sectionnement pour la vanne de purge de l'air  
Отсекающий кран для автоматического воздухоотводчика

Cod./Code	Misura/Size	□/田	€
183703031	3/8"	50/900	
183705051	1/2"	50/900	

## IVR 838



Valvola sfogo aria per radiatore manuale / orientabile, nichelata  
 Automatic air-vent for radiators, nickel-plated - Manual / Orientable  
 Entlüftungsventil für Heizkörper vernickelt, - Manuelles Entlüftung - einstellbar  
 Vanne purgeur d'air pour radiateur, nickelée - Vanne manuelle de purge d'air orientable  
 Воздухоотводчик для радиаторов, никелированный - ручной / регулируемый

Cod./Code	Misura/Size	□/田	€
183803001	3/8"	100/1200	
183805001	1/2"	100/1200	

## IVR 836 DRAIN



Rubinetto orientabile di carico-scarico  
 Water fill & drain valve  
 Ausrichtbares Ein-/Ablassventil von Wasser  
 Robinet orientable de chargement/déchargement de l'eau  
 Регулируемый дренажный клапан

Cod./Code	Misura/Size	□/田	€
183605001	1/2"	10/120	

## IVR 836/I DRAIN

**NEW**



Rubinetto orientabile di carico-scarico  
 Drain valve  
 Ausrichtbares Wasserfüllung und-Entleerungshahn  
 Robinet orientable de chargement/évacuation eau  
 Регулируемый уклонный дренажный клапан

Cod./Code	Misura/Size	□/田	€
183605100	1/2"	10/120	

## IVR 836/IP DRAIN

**NEW**



Rubinetto orientabile inclinato di carico-scarico in tecnopolimero  
 Rotating angle fill & drain valve in technopolymer  
 Drehbares Ein-/Anlassventil aus Technopolymere  
 Robinet orientable de chargement/déchargement en technopolymère  
 Регулируемый уклонный дренажный клапан из технополимера

Cod./Code	Misura/Size	□/田	€
183605150	1/2"	10/120	

## IVR 411 RACCORDI TERMINALI



Raccordo terminale M con autotenuta, nichelato  
Manifold plug. Nickel-plated - M with auto-seal  
Endanschluss. Vernickelt - AG mit Selbstdichtung  
Raccord terminal. Nickelé - M avec auto-étanche  
Концевое никелированное соединение для коллектора с наружной резьбой и самогерметизацией

Cod./Code	Misura/Size	□/田	€
141107531	3/4" M x 1/2" x 3/8"	10/150	
141110531	1" M x 1/2" x 3/8"	10/150	
141112531	1"1/4 M x 1/2" x 3/8"	10 /50	

## IVR 408



Raccordo terminale M con autotenuta e dado, nichelato  
Manifold plug. Nickel-plated - M with Auto-seal and nut  
Endanschluss - vernickelt - AG - mit Selbstdichtung und Überwurfmutter  
Raccord Terminal, nickelé - M avec joint et écrou  
Концевое никелированное соединение для коллектора с наружной резьбой, гайкой и самогерметизацией

Cod./Code	Misura/Size	□/田	€
140810551	1" x 1/2" x 1/2" TERM MAS C/GHI	20/180	

## IVR 405 NIPLO



Nipples con autotenuta, nichelato  
Nickel-plated auto-seal nipples  
Vernickeltes Nippel mit Selbstdichtung  
Raccords avec auto-étanche nickelés  
Ниппель с самогерметизацией, никелированный

Cod./Code	Misura/Size	□/田	€
140507001	3/4"	10/180	
140510001	1"	25/150	
140512001	1"1/4	10/180	



## IVR 407 NIPLO



Niples orientabile con autotenuta, nichelato  
 Nickel-plated rotatable nipple with auto-seal  
 Drehbares vernickeltes Nippel mit Selbstdichtung  
 Raccords orientables avec auto-étanche nickelés  
 Регулируемый ниппель с самогерметизацией, никелированный

Cod./Code	Misura/Size	□/田	€
140710001	1"	10/120	
140712001	1"1/4	10/120	

## IVR 311



Raccordo in tre pezzi con autotenuta e sede conica, dritto, nichelato  
 Three-piece fitting with auto seal. Nickel-plated - straight. Conical seat  
 Dreiteiliger Anschluss mit Selbstdichtung. Vernickelt - gerade. Kegelsitz  
 Raccord en trois pièces avec auto-étanche. Nickelé - droit. Siège conique  
 Трехсоставной фитинг с самогерметизацией, никелированный - прямой с коническим седлом

Cod./Code	Misura/Size	□/田	€
131107001	3/4"	10/120	
131110001	1"	10/120	

## IVR 316



Raccordo in tre pezzi con autotenuta e sede conica, a gomito, nichelato  
 Three pieces fitting with auto seal. Nickel-plated - elbow  
 Dreiteiliger winkel Anschluss - selbstdichtend - vernickelt  
 Raccord trois pièces autoétanche, nickelé - Courbé  
 Трехсоставной фитинг с самогерметизацией, никелированный с коническим седлом, согнут под прямым углом

Cod./Code	Misura/Size	□/田	€
131607001	3/4"	10/80	
131610001	x 1"	10/40	

## IVR 896



Set collegamento (4 pezzi) per AVANT FLOOR  
 Connection set (4 pcs) for AVANT FLOOR  
 Anschlussgarnitur (4 Stk.) für AVANT FLOOR  
 Kit connexion (4 pièces) pour AVANT FLOOR  
 Комплект содинений (4 шт) для коллекторов AVANT FLOOR

Cod./Code	Misura/Size	□/田	€
189610101	1" x 1"	10/40	

## IVR 412



Tappo F - nichelato  
 F plug - Nickel-plated  
 Deckel IG - vernickelt  
 Bouchon F nickelé  
 Никелированная заглушка с внутренней резьбой

Cod./Code	Misura/Size	□/田	€
141204001	24 - 19	50/600	
141205001	1/2"	50/900	
141207001	3/4"	50/600	
141210001	1"	25/300	



## IVR 414



Tappo M per collettore nichelato  
M plug for manifolds IVR 893. Nickel-plated  
Deckel AG für IVR 893. Vernickelt  
Bouchon M pour IVR 893. Nickelé  
Никелированная заглушка с наружной резьбой для коллекторов

Cod./Code	Misura/Size	□/田	€
141405001	1/2"	50/600	
141407001	3/4"	50/600	
141410001	1"	50/400	
141412001	1"1/4	50/200	
141420001	2"	10/60	

## IVR 415



Riduzione M/F nichelata  
M/F open plug. Nickel-plated  
Deckel AG/IG. Vernickelt  
Bouchon M/F. Nickelé  
Переходник Н/В, никелированный

Cod./Code	Misura/Size	□/田	€
141507031	3/4" M x 3/8" F	50/600	
141507051	3/4" M x 1/2" F	50/600	
141510031	1" M x 3/8" F	50/400	
141510051	1" M x 1/2" F	50/400	
141510071	1" M x 3/4" F	50/400	
141512051	1"1/4 M x 1/2" F	50/250	
141512101	1"1/4 M x 1" F	50/250	

## IVR 829

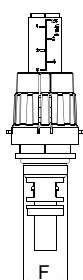

Misuratore di portata in ottone  
Flow meter in brass  
Durchflussmesser aus Messing  
Mesureur de débit en laiton  
Расходомер из латуни

Cod./Code	Misura/Size	F	□/田	€
182910105	0,5 ÷ 5 l/min - per/for AVANT FLOOR	1/2"	15/60	
182910108	0,5 ÷ 8 l/min - per/for AVANT FLOOR	1/2"	15/60	

## IVR 829/P

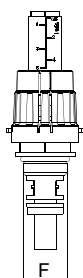

Misuratore di portata in tecnopolimero  
Flow meter in technopolymer  
Durchflussmesser aus Technopolymer  
Mesureur de débit en technopolymère  
Расходомер из технополимера

Cod./Code	Misura/Size	F	□/田	€
182910155	0,5 ÷ 5 l/min - per/for AVANT FLOOR	1/2"	15/60	

## IVR MULTIKLIMA 483



Dimensioni - Sizes - Maßen - Fixation - Размеры:  
H = 550 mm • L = 550 mm • P = 110-150 mm

Modulo IVR MULTIKLIMA 483 con valvola 3 vie con by pass, bilanciamento statico e miscelatore ACS/AFS  
IVR MULTIKLIMA 483 Metering unit - with 3-way valve with by-pass, static balancing valve and HSW/CSW mixing valve

IVR MULTIKLIMA 483 Zählermodul mit 3-Wege Kugelhahn mit Bypass, statischem Ausgleich und Warm oder-Kaltwassermischung

IVR MULTIKLIMA 483 Module pour la comptabilisation avec vanne à 3 voies avec by-pass, vanne d'équilibrage statique et mitigeur ECS/EFS

IVR MULTIKLIMA 483 - Узел учета с трёхходовым клапаном с бай-пассом, статическим балансировочным и смесительным клапаном ГВС/ХВС



### IVR MULTIKLIMA 483 PLUS

Modulo IVR MULTIKLIMA 483 PLUS con linea per acqua di servizio

IVR MULTIKLIMA 483 PLUS Metering Set with additional grey water line

IVR MULTIKLIMA 483 PLUS Zählermodul mit zusätzlicher Nutzwasserleitung

IVR MULTIKLIMA 483 PLUS Module pour la comptabilisation avec la ligne additionnelle de l'eau de récupération

IVR MULTIKLIMA 483 Plus с линией дополнительной подачи для технической воды



**D** Lettura diretta  
Direct visual display  
Direktauslesung  
Lecture directe  
Система прямого считывания



**M** Lettura M-Bus  
M-Bus data transmission  
M-Bus-Auslesung  
Lecture M-Bus  
Система диспетчеризации M-Bus (М-Бас)



**R** Lettura Radio  
Radio data transmission  
Funkauslesung  
Lecture Radio  
Система Радио



**H** Solo riscaldamento.  
Heating  
Heizung  
Chauffage  
Отопление



**H/C** Risc. / Raffresc.  
Heating / cooling  
Heizen / Kühlen  
Chauffage / refroidissement  
Отопление / охлаждение



**MIX** Con miscelatore ACS/AFS  
With mixing valve HSW/CSW  
Modul mit Warm-/Kaltwassermischung  
Mitigeur ECS/EFS  
Со смесительным клапаном ГВС/ХВС

### COMPLETE DI MISURATORI - WITH FLOW METERS

LINEE RISCALDAMENTO - HEATING RANGE					
D/M/R	Q3	H/C	COD. SX. LEFT	COD. DX. RIGHT	€
D	1,5 mc/h	H	M83D012G02	M83D112G02	
D	1,5 mc/h	H/C	M83D014G02	M83D114G02	
D	2,5 mc/h	H	M83D022G02	M83D122G02	
D	2,5 mc/h	H/C	M83D024G02	M83D124G02	
M	1,5 mc/h	H	M83M012G02	M83M112G02	
M	1,5 mc/h	H/C	M83M014G02	M83M114G02	
M	2,5 mc/h	H	M83M022G02	M83M122G02	
M	2,5 mc/h	H/C	M83M024G02	M83M124G02	
R	1,5 mc/h	H	M83R012G02	M83R112G02	
R	1,5 mc/h	H/C	M83R014G02	M83R114G02	
R	2,5 mc/h	H	M83R022G02	M83R122G02	
R	2,5 mc/h	H/C	M83R024G02	M83R124G02	

LINEE SANITARIE - SANITARY HOT AND COLD WATER LINES				
D/M/R	QP	AFS/ACS	CODICE	€
D	2,5 mc/h	ACS/HSW	ML1D020G02	
D	2,5 mc/h	AFS/CSW	ML0D020G02	
D	2,5 mc/h	DUALE/GREY	ML0D020G02	
D	2,5 mc/h	MIX	ML2D02MG02	
M	2,5 mc/h	ACS/HSW	ML1M020G02	
M	2,5 mc/h	AFS/CSW	ML0M020G02	
M	2,5 mc/h	DUALE/GREY	ML0M020G02	
M	2,5 mc/h	MIX	ML2M02MG02	
R	2,5 mc/h	ACS/HSW	ML1R020G02	
R	2,5 mc/h	AFS/CSW	ML0R020G02	
R	2,5 mc/h	DUALE/GREY	ML0R020G02	
R	2,5 mc/h	MIX	ML2R02MG02	

### SENZA MISURATORI CON TRONCHETTO SPAZIATORE - WITHOUT FLOW METERS WITH CONNECTION PIPES

LINEE RISCALDAMENTO - HEATING RANGE			
Q3	H/C	COD. SX/DX	€
3/4" F x 110 mm	H - H/C	M83B010A02	
1" F x 130 mm	H - H/C	M83B020A02	

LINEE SANITARIE - SANITARY HOT AND COLD WATER LINES			
QP	AFS/ACS	COD. SX/DX	€
3/4" F x 110 mm	ACS/HSW	ML1B020G02	
3/4" F x 110 mm	AFS/CSW	ML0B020G02	
3/4" F x 110 mm	MIX	ML2B02MG02	
3/4" F x 110 mm	DUALE/GREY	ML4B020G02	

### CASSETTE, ZANCHE, ARMADI MULTIUTENZA - CABINETS, BRACKETS, MULTI-USERS CABINETS

CASSETTA / ZANCHE - CABINETS/BRACKETS			
D/M/R	DIMENSIONI	COD. SX/DX	€
D/M	550 X 550	MB55027D01	
R	550 X 550	MB55027R01	
D/M	650 X 550	MB65027D01	
R	650 X 550	MB65027R01	
ZANCA	350 X 550	MB01527Z01	
ZANCA	550 X 550	MB05527Z01	
ZANCA	650 X 550	MB06527Z01	

CASSETTA MULTIUTENZA - MULTI-USER CABINETS			
D/M/R	DIMENSIONI	COD. SX/DX	€
D/M	2 UTENZE 1080 X 550	MB72027D01	
R	2 UTENZE 1080 X 550	MB72027R01	
D/M	3 UTENZE 1630 X 550	MB73027D01	
R	3 UTENZE 1630 X 550	MB73027R01	
D/M	4 UTENZE 2180 X 550	MB74027D01	
R	4 UTENZE 2180 X 550	MB74027R01	

## IVR MULTIKLIMA 473



Dimensioni - Sizes - Maßen - Fixation - Размеры:  
H = 550 mm • L = 550 mm • P = 110-150 mm

Modulo IVR MULTIKLIMA 473 - con valvola 3 vie con by pass e miscelatore ACS/AFS  
IVR MULTIKLIMA 473 Metering Set - with 3 ways valve with by pass and mixing valve DHW/DCW  
IVR MULTIKLIMA 473 Modul mit 3 Wege Kugelhahn mit Bypass und Warm-/Kaltwassermischung  
IVR MULTIKLIMA 473 Module pour la comptabilisation avec vanne à 3 voies avec by-pass et mitigeur ECS/EFS  
IVR MULTIKLIMA 473 Узел учета - с трехходовым клапаном, бай-пассом и смесительным клапаном ГВС/ХВС



### IVR MULTIKLIMA 473 PLUS

Modulo IVR MULTIKLIMA 473 PLUS con linea per acqua di servizio  
IVR MULTIKLIMA 473 PLUS Metering Set with additional grey water line  
IVR MULTIKLIMA 473 PLUS Zählermodul mit zusätzlicher Nutzwasserleitung  
IVR MULTIKLIMA 473 PLUS Module pour la comptabilisation avec la ligne additionnelle de l'eau de récupération  
IVR MULTIKLIMA 473 Plus с линией дополнительной подачи для технической воды

<b>D</b> Lettura diretta Direct visual display Direktauslesung Lecture directe Система прямого считывания	<b>M</b> Lettura M-Bus M-Bus data transmission M-Bus-Auslesung Lecture M-Bus Система диспетчеризации M-Bus (M-Bac)	<b>R</b> Lettura Radio Radio data transmission Funkauslesung Lecture Radio Система Радио	<b>H</b> Solo riscaldam. Heating Heizung Chauffage Отопление	<b>H/C</b> Risc. / Raffresc. Heating / cooling Heizen / Kühlen Chauffage / refroidissement Отопление / охлаждение	<b>MIX</b> Con miscelatore ACS/AFS With mixing valve HSW/CSW Modul mit Warm-/Kaltwassermischung Mitigeur ECS/EFS Со смесительным клапаном ГВС/ХВС
--	---	---	---	--	--

### COMPLETE DI MISURATORI - WITH FLOW METERS

LINEE RISCALDAMENTO - HEATING RANGE					
D/M/R	Q3	H/C	COD. SX. LEFT	COD. DX RIGHT	€
D	1,5 mc/h	H	M73D012G02	M73D112G02	
D	1,5 mc/h	H/C	M73D014G02	M73D114G02	
D	2,5 mc/h	H	M73D022G02	M73D122G02	
D	2,5 mc/h	H/C	M73D024G02	M73D124G02	
M	1,5 mc/h	H	M73M012G02	M73M112G02	
M	1,5 mc/h	H/C	M73M014G02	M73M114G02	
M	2,5 mc/h	H	M73M022G02	M73M122G02	
M	2,5 mc/h	H/C	M73M024G02	M73M124G02	
R	1,5 mc/h	H	M73R012G02	M73R012G02	
R	1,5 mc/h	H/C	M73R014G02	M73R114G02	
R	2,5 mc/h	H	M73R022G02	M73R122G02	
R	2,5 mc/h	H/C	M73R024G02	M73R124G02	

LINEE SANITARIE - SANITARY HOT AND COLD WATER LINES				
D/M/R	QP	AFS/ACS	CODICE	€
D	2,5 mc/h	ACS/HSW	ML1D020G02	
D	2,5 mc/h	AFS/CSW	ML0D020G02	
D	2,5 mc/h	DUALE/GREY	ML0D020G02	
D	2,5 mc/h	MIX	ML2D02MG02	
M	2,5 mc/h	ACS/HSW	ML1M020G02	
M	2,5 mc/h	AFS/CSW	ML0M020G02	
M	2,5 mc/h	DUALE/GREY	ML0M020G02	
M	2,5 mc/h	MIX	ML2M02MG02	
R	2,5 mc/h	ACS/HSW	ML1R020G02	
R	2,5 mc/h	AFS/CSW	ML0R020G02	
R	2,5 mc/h	DUALE/GREY	ML0R020G02	
R	2,5 mc/h	MIX	ML2R02MG02	

### SENZA MISURATORI CON TRONCHETTO SPAZIATORE - WITHOUT FLOW METERS WITH CONNECTION PIPES

LINEE RISCALDAMENTO - HEATING RANGE			
Q3	H/C	COD. SX/DX	€
3/4" F x 110 mm	H - H/C	M73B010A02	
1" F x 130 mm	H - H/C	M73B020A02	

LINEE SANITARIE - SANITARY HOT AND COLD WATER LINES			
QP	AFS/ACS	COD. SX/DX	€
3/4" F x 110 mm	ACS/HSW	ML1B020G02	
3/4" F x 110 mm	AFS/CSW	ML0B020G02	
3/4" F x 110 mm	MIX	ML2B02MG02	
3/4" F x 110 mm	DUALE/GREY	ML4B020G02	

### CASSETTE, ZANCHE, ARMADI MULTIUTENZA - CABINETS, BRACKETS, MULTI-USERS CABINETS

CASSETTA / ZANCHE - CABINETS/BRACKETS			
D/M/R	DIMENSIONI	COD. SX/DX	€
D/M	550 X 550	MB55027D01	
R	550 X 550	MB55027R01	
D/M	650 X 550	MB65027D01	
R	650 X 550	MB65027R01	
ZANCA	350 X 550	MB01527Z01	
ZANCA	550 X 550	MB05527Z01	
ZANCA	650 X 550	MB06527Z01	

CASSETTA MULTIUTENZA - MULTI-USER CABINETS			
D/M/R	DIMENSIONI	COD. SX/DX	€
D/M	2 UTENZE 1080 X 550	MB72027D01	
R	2 UTENZE 1080 X 550	MB72027R01	
D/M	3 UTENZE 1630 X 550	MB73027D01	
R	3 UTENZE 1630 X 550	MB73027R01	
D/M	4 UTENZE 2180 X 550	MB74027D01	
R	4 UTENZE 2180 X 550	MB74027R01	

## IVR MULTIKLIMA 482









Dimensioni - Sizes - Maßen - Fixation - Размеры:  
H = 550 mm • L = 550 mm • P = 110-150 mm

Modulo IVR MULTIKLIMA 482 - con valvola 2 vie, bilanciamento statico e miscelatore ACS/AFS  
IVR MULTIKLIMA 482 Metering Set - with 2 ways valve, static balancing valve and mixing valve DHW/DCW  
IVR MULTIKLIMA 482 Modul mit 2 Wege Kugelhahn, statischem Ausgleich und Warm-/Kaltwasseremischung  
Module IVR MULTIKLIMA 482 avec vanne 2 voies, vanne d'équilibrage statique et mitigeur ECS/EFS  
IVR MULTIKLIMA 482 Узел учета - с двухходовым клапаном, статическим балансирующим клапаном и смесительным клапаном ГВС/ХВС



### IVR MULTIKLIMA 482 PLUS

Modulo IVR MULTIKLIMA 482 PLUS con linea per acqua di servizio  
IVR MULTIKLIMA 482 PLUS Metering Set with additional grey water line  
IVR MULTIKLIMA 482 PLUS Zählermodul mit zusätzlicher Nutzwasserleitung  
IVR MULTIKLIMA 482 PLUS Module pour la comptabilisation avec la ligne additionnelle de l'eau de récupération  
IVR MULTIKLIMA 482 Plus с линией дополнительной подачи для технической воды

<b>D</b>  Lettura diretta Direct visual display Direktauslesung Lecture directe Система прямого считывания	<b>M</b>  Lettura M-Bus M-Bus data transmission M-Bus-Auslesung Lecture M-Bus Система диспетчеризации M-Bus (M-Бас)	<b>R</b>  Lettura Radio Radio data transmission Funkauslesung Lecture Radio Система Радио	<b>H</b>  Solo riscaldamento. Heating Heizung Chauffage Отопление	<b>H/C</b>  Risc. / Raffresc. Heating / cooling Heizen / Kühlen Chauffage / refroidissement Отопление / охлаждение	<b>MIX</b>  Con miscelatore ACS/AFS With mixing valve HSW/CSW Modul mit Warm-/Kaltwasseremischung Mitigeur ECS/EFS Со смесительным клапаном ГВС/ХВС
--	---	---	---	---	---

### COMPLETE DI MISURATORI - WITH FLOW METERS

LINEE RISCALDAMENTO - HEATING RANGE						LINEE SANITARIE - SANITARY HOT AND COLD WATER LINES				
D/M/R	Q3	H/C	COD. SX. LEFT	COD. DX. RIGHT	€	D/M/R	QP	AFS/ACS	CODICE	€
D	1,5 mc/h	H	M82D012G02	M82D112G02		D	2,5 mc/h	ACS/HSW	ML1D020G02	
D	1,5 mc/h	H/C	M82D014G02	M82D114G02		D	2,5 mc/h	AFS/CSW	ML0D020G02	
D	2,5 mc/h	H	M82D022G02	M82D122G02		D	2,5 mc/h	DUALE/GREY	ML0D020G02	
D	2,5 mc/h	H/C	M82D024G02	M82D124G02		D	2,5 mc/h	MIX	ML2D02MG02	
M	1,5 mc/h	H	M82M012G02	M82M112G02		M	2,5 mc/h	ACS/HSW	ML1M020G02	
M	1,5 mc/h	H/C	M82M014G02	M82M114G02		M	2,5 mc/h	AFS/CSW	ML0M020G02	
M	2,5 mc/h	H	M82M022G02	M82M022G02		M	2,5 mc/h	DUALE/GREY	ML0M020G02	
M	2,5 mc/h	H/C	M82M024G02	M82M124G02		M	2,5 mc/h	MIX	ML2M02MG02	
R	1,5 mc/h	H	M82R012G02	M82R112G02		R	2,5 mc/h	ACS/HSW	ML1R020G02	
R	1,5 mc/h	H/C	M82R014G02	M82R114G02		R	2,5 mc/h	AFS/CSW	ML0R020G02	
R	2,5 mc/h	H	M82R022G02	M82R122G02		R	2,5 mc/h	DUALE/GREY	ML0R020G02	
R	2,5 mc/h	H/C	M82R024G02	M82R124G02		R	2,5 mc/h	MIX	ML2R02MG02	

### SENZA MISURATORI CON TRONCHETTO SPAZIATORE - WITHOUT FLOW METERS WITH CONNECTION PIPES

LINEE RISCALDAMENTO - HEATING RANGE				LINEE SANITARIE - SANITARY HOT AND COLD WATER LINES			
Q3	H/C	COD. SX/DX	€	QP	AFS/ACS	COD. SX/DX	€
3/4" F x 110 mm	H - H/C	M82B010A02		3/4" F x 110 mm	ACS/HSW	ML1B020G02	
1" F x 130 mm	H - H/C	M82B020A02		3/4" F x 110 mm	AFS/CSW	ML0B020G02	
				3/4" F x 110 mm	MIX	ML2B02MG02	
				3/4" F x 110 mm	DUALE/GREY	ML4B020G02	

### CASSETTE, ZANCHE, ARMADI MULTIUTENZA - CABINETS, BRACKETS, MULTI-USERS CABINETS

CASSETTA / ZANCHE - CABINETS/BRACKETS				CASSETTA MULTIUTENZA - MULTI-USER CABINETS			
D/M/R	DIMENSIONI	COD. SX/DX	€	D/M/R	DIMENSIONI	COD. SX/DX	€
D/M	550 X 550	MB55027D01		D/M	2 UTENZE 1080 X 550	MB72027D01	
R	550 X 550	MB55027R01		R	2 UTENZE 1080 X 550	MB72027R01	
D/M	650 X 550	MB65027D01		D/M	3 UTENZE 1630 X 550	MB73027D01	
R	650 X 550	MB65027R01		R	3 UTENZE 1630 X 550	MB73027R01	
ZANCA	350 X 550	MB01527Z01		D/M	4 UTENZE 2180 X 550	MB74027D01	
ZANCA	550 X 550	MB05527Z01		R	4 UTENZE 2180 X 550	MB74027R01	
ZANCA	650 X 550	MB06527Z01					



## IVR MULTIKLIMA 472



Dimensioni - Sizes - Maßen - Fixation - Размеры:  
H = 550 mm • L = 550 mm • P = 110-150 mm

Modulo IVR MULTIKLIMA 472 - con valvola 2 vie e miscelatore ACS/AFS  
IVR MULTIKLIMA 472 Metering Set - with 2 ways valve and mixing valve DHW/DCW  
IVR MULTIKLIMA 472 Modul mit 2 Wege Kugelhahn und Warm-/Kaltwassermischung  
Module IVR MULTIKLIMA 472 avec vanne 2 voies et mitigeur ECS/EFS  
IVR MULTIKLIMA 472 Узел учета - с двухходовым клапаном и смесительным клапаном ГВС/ХВС



### IVR MULTIKLIMA 472 PLUS

Modulo IVR MULTIKLIMA 472 PLUS con linea per acqua di servizio  
IVR MULTIKLIMA 472 PLUS Metering Set with additional grey water line  
IVR MULTIKLIMA 472 PLUS Zählermodul mit zusätzlicher Nutzwasserleitung  
IVR MULTIKLIMA 472 PLUS Module pour la comptabilisation avec la ligne additionnelle de l'eau de récupération  
IVR MULTIKLIMA 472 Plus с линией дополнительной подачи для технической воды

<b>D</b> Lettura diretta Direct visual display Direktauslesung Lecture directe Система прямого считывания	<b>M</b> Lettura M-Bus M-Bus data transmission M-Bus-Auslesung Lecture M-Bus Система диспетчеризации M-Bus (M-Bac)	<b>R</b> Lettura Radio Radio data transmission Funkauslesung Lecture Radio Система Радио	<b>H</b> Solo riscaldam. Heating Heizung Chauffage Отопление	<b>H/C</b> Risc. / Raffresc. Heating / cooling Heizen / Kühlen Chauffage / refroidissement Отопление / охлаждение	<b>MIX</b> Con miscelatore ACS/AFS With mixing valve HSW/CSW Modul mit Warm-/Kaltwassermischung Mitigeur ECS/EFS Со смесительным клапаном ГВС/ХВС
--	---	---	---	--	--

### COMPLETE DI MISURATORI - WITH FLOW METERS

LINEE RISCALDAMENTO - HEATING RANGE						LINEE SANITARIE - SANITARY HOT AND COLD WATER LINES				
D/M/R	Q3	H/C	COD. SX. LEFT	COD. DX RIGHT	€	D/M/R	QP	AFS/ACS	CODICE	€
D	1,5 mc/h	H	M72D012G02	M72D112G02		D	2,5 mc/h	ACS/HSW	ML1D020G02	
D	1,5 mc/h	H/C	M72D014G02	M72D114G02		D	2,5 mc/h	AFS/CSW	ML0D020G02	
D	2,5 mc/h	H	M72D022G02	M72D122G02		D	2,5 mc/h	DUALE/GREY	ML0D020G02	
D	2,5 mc/h	H/C	M72D024G02	M72D124G02		D	2,5 mc/h	MIX	ML2D02MG02	
M	1,5 mc/h	H	M72M012G02	M72M112G02		M	2,5 mc/h	ACS/HSW	ML1M020G02	
M	1,5 mc/h	H/C	M72M014G02	M72M114G02		M	2,5 mc/h	AFS/CSW	ML0M020G02	
M	2,5 mc/h	H	M72M022G02	M72M022G02		M	2,5 mc/h	DUALE/GREY	ML0M020G02	
M	2,5 mc/h	H/C	M72M024G02	M72M124G02		M	2,5 mc/h	MIX	ML2M02MG02	
R	1,5 mc/h	H	M72R012G02	M72R112G02		R	2,5 mc/h	ACS/HSW	ML1R020G02	
R	1,5 mc/h	H/C	M72R014G02	M72R114G02		R	2,5 mc/h	AFS/CSW	ML0R020G02	
R	2,5 mc/h	H	M72R022G02	M72R122G02		R	2,5 mc/h	DUALE/GREY	ML0R020G02	
R	2,5 mc/h	H/C	M72R024G02	M72R124G02		R	2,5 mc/h	MIX	ML2R02MG02	

### SENZA MISURATORI CON TRONCHETTO SPAZIATORE - WITHOUT FLOW METERS WITH CONNECTION PIPES

LINEE RISCALDAMENTO - HEATING RANGE				LINEE SANITARIE - SANITARY HOT AND COLD WATER LINES			
Q3	H/C	COD. SX/DX	€	QP	AFS/ACS	COD. SX/DX	€
3/4" F x 110 mm	H - H/C	M72B010A02		3/4" F x 110 mm	ACS/HSW	ML1B020G02	
1" F x 130 mm	H - H/C	M72B020A02		3/4" F x 110 mm	AFS/CSW	ML0B020G02	
				3/4" F x 110 mm	MIX	ML2B02MG02	
				3/4" F x 110 mm	DUALE/GREY	ML4B020G02	

### CASSETTE, ZANCHE, ARMADI MULTIUTENZA - CABINETS, BRACKETS, MULTI-USERS CABINETS

CASSETTA / ZANCHE - CABINETS/BRACKETS				CASSETTA MULTIUTENZA - MULTI-USER CABINETS			
D/M/R	DIMENSIONI	COD. SX/DX	€	D/M/R	DIMENSIONI	COD. SX/DX	€
D/M	550 X 550	MB55027D01		D/M	2 UTENZE 1080 X 550	MB72027D01	
R	550 X 550	MB55027R01		R	2 UTENZE 1080 X 550	MB72027R01	
D/M	650 X 550	MB65027D01		D/M	3 UTENZE 1630 X 550	MB73027D01	
R	650 X 550	MB65027R01		R	3 UTENZE 1630 X 550	MB73027R01	
ZANCA	350 X 550	MB01527Z01		D/M	4 UTENZE 2180 X 550	MB74027D01	
ZANCA	550 X 550	MB05527Z01		R	4 UTENZE 2180 X 550	MB74027R01	
ZANCA	650 X 550	MB06527Z01					



## IVR MULTIKLIMA 481









Dimensioni - Sizes - Maßen - Fixation - Размеры:  
H = 550 mm • L = 550 mm • P = 110-150 mm

Modulo IVR MULTIKLIMA 481 - con bilanciamento statico e miscelatore ACS/AFS  
IVR MULTIKLIMA 481 Metering Set - with static balancing valve and mixing valve DHW/DCW  
IVR MULTIKLIMA 481 Modul mit statischem Ausgleich und Warm-/Kaltwassermischung  
Module IVR MULTIKLIMA 481 avec vanne d'équilibrage statique et mitigeur ECS/EFS  
IVR MULTIKLIMA 481- Узел учета со статическим балансировочным клапаном и смесительным клапаном ГВС/ХВС



### IVR MULTIKLIMA 481 PLUS

Modulo IVR MULTIKLIMA 481 PLUS con linea per acqua di servizio  
IVR MULTIKLIMA 481 PLUS Metering Set with additional grey water line  
IVR MULTIKLIMA 481 PLUS Zählermodul mit zusätzlicher Nutzwasserleitung  
IVR MULTIKLIMA 481 PLUS Module pour la comptabilisation avec la ligne additionnelle de l'eau de récupération  
IVR MULTIKLIMA 481 Plus с линией дополнительной подачи для технической воды

<b>D</b> 	Letture diretta Direct visual display Direktauslesung Lecture directe Система прямого считывания	<b>M</b> 	Letture M-Bus M-Bus data transmission M-Bus-Auslesung Lecture M-Bus Система диспетчеризации M-Bus (M-Бас)	<b>R</b> 	Letture Radio Radio data transmission Funkauslesung Lecture Radio Система Радио	<b>H</b> 	Solo riscaldamento. Heating Heizung Chauffage Отопление	<b>H/C</b> 	Risc. / Raffresc. Heating / cooling Heizen / Kühlen Chauffage / refroidissement Отопление / охлаждение	<b>MIX</b> 	Con miscelatore ACS/AFS With mixing valve HSW/CSW Modul mit Warm-/Kaltwassermischung Mitigeur ECS/EFS Со смесительным клапаном ГВС/ХВС
--	--	--	---	--	---	--	---	---	--	--	--

### COMPLETE DI MISURATORI - WITH FLOW METERS

LINEE RISCALDAMENTO - HEATING RANGE						LINEE SANITARIE - SANITARY HOT AND COLD WATER LINES				
D/M/R	Q3	H/C	COD. SX. LEFT	COD. DX. RIGHT	€	D/M/R	QP	AFS/ACS	CODICE	€
D	1,5 mc/h	H	M81D012G02	M81D112G02		D	2,5 mc/h	ACS/HSW	ML1D020G02	
D	1,5 mc/h	H/C	M81D014G02	M81D114G02		D	2,5 mc/h	AFS/CSW	ML0D020G02	
D	2,5 mc/h	H	M81D022G02	M81D122G02		D	2,5 mc/h	DUALE/GREY	ML0D020G02	
D	2,5 mc/h	H/C	M81D024G02	M81D124G02		D	2,5 mc/h	MIX	ML2D02MG02	
M	1,5 mc/h	H	M81M012G02	M81M112G02		M	2,5 mc/h	ACS/HSW	ML1M020G02	
M	1,5 mc/h	H/C	M81M014G02	M81M114G02		M	2,5 mc/h	AFS/CSW	ML0M020G02	
M	2,5 mc/h	H	M81M022G02	M81M122G02		M	2,5 mc/h	DUALE/GREY	ML0M020G02	
M	2,5 mc/h	H/C	M81M024G02	M81M124G02		M	2,5 mc/h	MIX	ML2M02MG02	
R	1,5 mc/h	H	M81R012G02	M81R112G02		R	2,5 mc/h	ACS/HSW	ML1R020G02	
R	1,5 mc/h	H/C	M81R014G02	M81R114G02		R	2,5 mc/h	AFS/CSW	ML0R020G02	
R	2,5 mc/h	H	M81R022G02	M81R122G02		R	2,5 mc/h	DUALE/GREY	ML0R020G02	
R	2,5 mc/h	H/C	M81R024G02	M81R124G02		R	2,5 mc/h	MIX	ML2R02MG02	

### SENZA MISURATORI CON TRONCHETTO SPAZIATORE - WITHOUT FLOW METERS WITH CONNECTION PIPES

LINEE RISCALDAMENTO - HEATING RANGE				LINEE SANITARIE - SANITARY HOT AND COLD WATER LINES			
Q3	H/C	COD. SX/DX	€	QP	AFS/ACS	COD. SX/DX	€
3/4" F x 110 mm	H - H/C	M81B010A02		3/4" F x 110 mm	ACS/HSW	ML1B020G02	
1" F x 130 mm	H - H/C	M81B020A02		3/4" F x 110 mm	AFS/CSW	ML0B020G02	
				3/4" F x 110 mm	MIX	ML2B02MG02	
				3/4" F x 110 mm	DUALE/GREY	ML4B020G02	

### CASSETTE, ZANCHE, ARMADI MULTIUTENZA - CABINETS, BRACKETS, MULTI-USERS CABINETS

CASSETTA / ZANCHE - CABINETS/BRACKETS				CASSETTA MULTIUTENZA - MULTI-USER CABINETS			
D/M/R	DIMENSIONI	COD. SX/DX	€	D/M/R	DIMENSIONI	COD. SX/DX	€
D/M	550 X 550	MB55027D01		D/M	2 UTENZE 1080 X 550	MB72027D01	
R	550 X 550	MB55027R01		R	2 UTENZE 1080 X 550	MB72027R01	
D/M	650 X 550	MB65027D01		D/M	3 UTENZE 1630 X 550	MB73027D01	
R	650 X 550	MB65027R01		R	3 UTENZE 1630 X 550	MB73027R01	
ZANCA	350 X 550	MB01527Z01		D/M	4 UTENZE 2180 X 550	MB74027D01	
ZANCA	550 X 550	MB05527Z01		R	4 UTENZE 2180 X 550	MB74027R01	
ZANCA	650 X 550	MB06527Z01					

## IVR MULTIKLIMA 471



Dimensioni - Sizes - Maßen - Fixation - Размеры:  
H = 550 mm • L = 550 mm • P = 110-150 mm

Modulo IVR MULTIKLIMA 471 - con miscelatore ACS/AFS  
IVR MULTIKLIMA 471 Metering Set - with mixing valve DHW/DCW  
IVR MULTIKLIMA 471 Modul mit Warm-/Kaltwassermischung  
Module IVR MULTIKLIMA 471 Mitigeur ECS/EFS  
IVR MULTIKLIMA 471 Узел учета со смесительным клапаном ГВС/ХВС



### IVR MULTIKLIMA 471 PLUS

Modulo IVR MULTIKLIMA 471 PLUS con linea per acqua di servizio  
IVR MULTIKLIMA 471 PLUS Metering Set with additional grey water line  
IVR MULTIKLIMA 471 PLUS Zählermodul mit zusätzlicher Nutzwasserleitung  
IVR MULTIKLIMA 471 PLUS Module pour la comptabilisation avec la ligne additionnelle de l'eau de récupération  
IVR MULTIKLIMA 471 Plus с линией дополнительной подачи для технической воды

<b>D</b> Lettura diretta Direct visual display Direktauslesung Lecture directe Система прямого считывания	<b>M</b> Lettura M-Bus M-Bus data transmission M-Bus-Auslesung Lecture M-Bus Система диспетчеризации M-Bus (M-Bac)	<b>R</b> Lettura Radio Radio data transmission Funkauslesung Lecture Radio Система Радио	<b>H</b> Solo riscaldamento. Heating Heizung Chauffage Отопление	<b>H/C</b> Risc. / Raffresc. Heating / cooling Heizen / Kühlen Chauffage / refroidissement Отопление / охлаждение	<b>MIX</b> Con miscelatore ACS/AFS With mixing valve HSW/CSW Modul mit Warm-/Kaltwassermischung Mitigeur ECS/EFS Со смесительным клапаном ГВС/ХВС
--	---	---	---	--	--

### COMPLETE DI MISURATORI - WITH FLOW METERS

LINEE RISCALDAMENTO - HEATING RANGE						LINEE SANITARIE - SANITARY HOT AND COLD WATER LINES				
D/M/R	Q3	H/C	COD. SX. LEFT	COD. DX RIGHT	€	D/M/R	QP	AFS/ACS	CODICE	€
D	1,5 mc/h	H	M71D012G02	M71D112G02		D	2,5 mc/h	ACS/HSW	ML1D020G02	
D	1,5 mc/h	H/C	M71D014G02	M71D114G02		D	2,5 mc/h	AFS/CSW	ML0D020G02	
D	2,5 mc/h	H	M71D022G02	M71D122G02		D	2,5 mc/h	DUALE/GREY	ML0D020G02	
D	2,5 mc/h	H/C	M71D024G02	M71D124G02		D	2,5 mc/h	MIX	ML2D02MG02	
M	1,5 mc/h	H	M71M012G02	M71M112G02		M	2,5 mc/h	ACS/HSW	ML1M020G02	
M	1,5 mc/h	H/C	M71M014G02	M71M114G02		M	2,5 mc/h	AFS/CSW	ML0M020G02	
M	2,5 mc/h	H	M71M022G02	M71M122G02		M	2,5 mc/h	DUALE/GREY	ML0M020G02	
M	2,5 mc/h	H/C	M71M024G02	M71M124G02		M	2,5 mc/h	MIX	ML2M02MG02	
R	1,5 mc/h	H	M71R012G02	M71R112G02		R	2,5 mc/h	ACS/HSW	ML1R020G02	
R	1,5 mc/h	H/C	M71R014G02	M71R114G02		R	2,5 mc/h	AFS/CSW	ML0R020G02	
R	2,5 mc/h	H	M71R022G02	M71R122G02		R	2,5 mc/h	DUALE/GREY	ML0R020G02	
R	2,5 mc/h	H/C	M71R024G02	M71R124G02		R	2,5 mc/h	MIX	ML2R02MG02	

### SENZA MISURATORI CON TRONCHETTO SPAZIATORE - WITHOUT FLOW METERS WITH CONNECTION PIPES

LINEE RISCALDAMENTO - HEATING RANGE				LINEE SANITARIE - SANITARY HOT AND COLD WATER LINES			
Q3	H/C	COD. SX/DX	€	QP	AFS/ACS	COD. SX/DX	€
3/4" F x 110 mm	H - H/C	M71B010A02		3/4" F x 110 mm	ACS/HSW	ML1B020G02	
1" F x 130 mm	H - H/C	M71B020A02		3/4" F x 110 mm	AFS/CSW	ML0B020G02	
				3/4" F x 110 mm	MIX	ML2B02MG02	
				3/4" F x 110 mm	DUALE/GREY	ML4B020G02	

### CASSETTE, ZANCHE, ARMADI MULTIUTENZA - CABINETS, BRACKETS, MULTI-USERS CABINETS

CASSETTA / ZANCHE - CABINETS/BRACKETS				CASSETTA MULTIUTENZA - MULTI-USER CABINETS			
D/M/R	DIMENSIONI	COD. SX/DX	€	D/M/R	DIMENSIONI	COD. SX/DX	€
D/M	550 X 550	MB55027D01		D/M	2 UTENZE 1080 X 550	MB72027D01	
R	550 X 550	MB55027R01		R	2 UTENZE 1080 X 550	MB72027R01	
D/M	650 X 550	MB65027D01		D/M	3 UTENZE 1630 X 550	MB73027D01	
R	650 X 550	MB65027R01		R	3 UTENZE 1630 X 550	MB73027R01	
ZANCA	350 X 550	MB01527Z01		D/M	4 UTENZE 2180 X 550	MB74027D01	
ZANCA	550 X 550	MB05527Z01		R	4 UTENZE 2180 X 550	MB74027R01	
ZANCA	650 X 550	MB06527Z01					

## ACCESSORI MULTIKLIMA / MULTIKLIMA ACCESSORIES



Set 2 tubi di collegamento linee riscaldamento  
Set of 2 union pipes for heating lines  
Garnitur von 2 Anschlussrohren für die Heizungsleitungen  
Set de 2 tubes de connexion pour les lignes de chauffage  
Набор из 2-х соединительных труб для сегмента отопления

Cod./Code	□/田	€
4A00000A10	1	



Set 2 tubi di collegamento linee acqua sanitaria  
Set of 2 union pipes for sanitary water lines  
Garnitur von 2 Anschlussrohren für die Wasserleitungen  
Set de 2 tubes de connexion pour les lignes de l'eau sanitaire  
Набор из 2-х соединительных труб для сегмента санитарного водоснабжения

Cod./Code	□/田	€
4A00000A12	1	

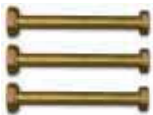

Set 3 tubi di collegamento linee acqua sanitaria e acqua duale di servizio  
Set of 3 union pipes for sanitary water and greywater lines  
Garnitur von 3 Anschlussrohren für Wasser- und Nutwasserleitungen  
Set de 3 tubes de connexion pour les lignes de l'eau sanitaire et de l'eau de récupération  
Набор из 3-х соединительных труб для сегментов санитарного и технического водоснабжения

Cod./Code	□/田	€
4A00000A13	1	



Set 4 di tubi collegamento linee riscaldamento e acqua sanitaria  
Set of 4 union pipes for heating and sanitary water lines  
Garnitur von 4 Anschlussrohren für Heizungs- und Wasserleitungen  
Set de 4 tubes pour les lignes de chauffage et de l'eau sanitaire  
Набор из 4-х соединительных труб для сегмента отопления и санитарного водоснабжения

Cod./Code	□/田	€
4A00000A14	1	



Set 5 di tubi collegamento linee riscaldamento, acqua sanitaria e acqua duale di servizio  
Set of 5 union pipes for heating, sanitary water and greywater lines  
Garnitur von 4 Anschlussrohren für Heizungs- und Wasserleitungen  
Set de 5 tubes pour les lignes de chauffage, de l'eau sanitaire et de l'eau de récupération  
Набор из 5 соединительных труб для сегментов санитарного и технического водоснабжения

Cod./Code	□/田	€
4A00000A15	1	



Guscio di coibentazione per linee di riscaldamento/raffrescamento  
Insulating shell for heating/cooling lines  
Isolierhülse für Heizung/Erkältungsleitungen  
Coque isolante pour les lignes de chauffage/rafraîchissement  
Изолирующая оболочка для систем нагрева / охлаждения

Cod./Code	□/田	€
335800412	SX	1
335800413	DX	1



Centralina Datalogger M-Bus  
M-Bus Data logger  
M-Bus Datenlogger  
Data logger M-Bus  
Регистратор данных M-Bus

Cod./Code	□/田	€
149600060	60	1
149600120	120	1
149600250	250	1



Convertitore di segnale M-Bus fissaggio a muro  
M-Bus signal converter - wall mounting  
M-Bus Signalumsetzer - Wandbefestigung  
Convertisseur de signal - fixé au mur  
Конвертирующий адаптер сигнала M-Bus - настенный монтаж

Cod./Code	□/田	€
335800107	1	



MODEM GSM trasmissione dati con antenna  
GSM MODEM for antenna data transmission  
GSM MODEM für Übertragungen mittels Antenne  
MODEM GSM pour les transmissions avec antenne  
МОДЕМ GSM - прибор передачи данных с антенной

Cod./Code	□/田	€
1497PY001	1	

## VALVOLE PER RADIATORI / RADIATOR VALVES

Valvole termostatiche / Thermostatic valves  
THERMOCHROME



KIT TERMOARREDO composto da valvola termostattizzabile e detentore, cromati  
KIT for design radiator with thermostatic valve and lockshield, chrome-plated  
DESIGNGARNITUR: Regulierventil (für Thermostat) und Rücklaufverschraubung, verchromt  
KIT pour radiateurs design composé de vanne thermostatizable et coude de réglage chromés  
Комплект для дизайнерских радиаторов, состоящий из термостатического и отсекающего клапанов, хромированный

### IVR 597 CHR



Testa termostatica con sensore a liquido; a bassa inerzia termica - Cromata  
Thermostatic head with liquid sensor; low thermal inertia - Chrome-plated  
Thermostatkopf mit Flüssigkeitssensor; geringe thermische Trägheit - Verchromt  
Tête thermostatique avec capteur à liquide - à faible inertie thermique - Chromée  
Термостатическая головка с жидкостным сенсором; с низкой термоинерцией - Хромированная

Cod./Code	Misura/Size	□/田	€
159700701	M30 x 1,5	1/50	

### IVR 777 CHR



A squadra, attacco tubo rame, PEX e multistrato  
Angle, PEX, multilayer and copper pipe connection  
Eckförmig, Anschluss für Kupfer, PEX und Mehrschichtrohr  
Équerre, fixation tube en cuivre, PEX et multicouche  
Угловой, соединение для медной, PEX и многослойной трубы

Cod./Code	Misura/Size	Attacco/Connection	□/田	€
177705185	1/2"	24-19	1/15	

### IVR 563 CHR



THERMOCHROME, valvola termostattizzabile a squadra, attacco PEX, multistrato e tubo rame, bocchettone autotenuta, cromata  
THERMOCHROME, chrome-plated angle thermostatic valve, PEX, multilayer and copper pipe connection, autoeal tail piece  
THERMOCHROME, Eckthermostatventil, Anschluss für PEX, Kupfer- und Mehrschichtrohr, mit Selbstdichtung, verchromt  
THERMOCHROME, vanne thermostatizable équerre, fixation PEX, multicouche et tube en cuivre, raccord avec auto-étanche, chromée  
THERMOCHROME, термостатический угловой клапан, соединение для PEX, металлопластиковой и стальной трубы. С самогерметизирующимся патрубком. хромированный.

Cod./Code	Misura/Size	Attacco/Connection	□/田	€
156305187	1/2"	24-19	1/18	

## IVR 557 CHR

**NEW**



THERMOCHROME, detentore a squadra, attacco PEX, multistrato e tubo rame, bocchettone autotenuta, cromato

THERMOCHROME, chrome-plated angle lockshield, PEX, multilayer and copper pipe connection, autoseal tail piece

THERMOCHROME, Eckrücklaufverschraubung, Anschluss für PEX, für Kupfer- und Mehrschichtrohr, mit Selbstdichtung, verchromt

THERMOCHROME, coude de réglage équerre, fixation PEX, multicouche et tube en cuivre, chromé

THERMOCHROME, угловой стопорный клапан, соединение для PEX, металлопластиковой и стальной трубы. С самогерметизирующимся патрубком. хромированный.

Cod./Code	Misura/Size	Attacco/Connection	□/田	€
155705187	1/2"	24-19	1/18	

## IVR 776 CHR



Dritto, attacco tubo rame, PEX e multistrato

Straight, PEX, multilayer and copper pipe connection

gerade, Anschluss für Kupfer, PEX und Mehrschichtrohr

Droit, fixation tube en cuivre, PEX et multicouche

Прямой, соединение для медной, PEX и многослойной трубы

Cod./Code	Misura/Size	Attacco/Connection	□/田	€
177605185	1/2"	24-19	1/15	

## IVR 562 CHR

**NEW**



THERMOCHROME, valvola termostattabile diritta, attacco PEX, multistrato e tubo rame, bocchettone autotenuta, cromata

THERMOCHROME, chrome-plated straight thermostatic valve, PEX, multilayer and copper pipe connection, autoseal tail piece

THERMOCHROME, Gerade Thermostatventil, Anschluss für PEX, Kupfer- und Mehrschichtrohr, mit Selbstdichtung, verchromt

THERMOCHROME, vanne thermostatizable droite, fixation PEX, multicouche et tube en cuivre, raccord avec auto-étanche, chromée

THERMOCHROME, термостатический прямой клапан, соединение для PEX, металлопластиковой и стальной трубы. С самогерметизирующимся патрубком. хромированный.

Cod./Code	Misura/Size	Attacco/Connection	□/田	€
156205187	1/2"	24-19	1/18	

## IVR 555 CHR

**NEW**



THERMOCHROME, detentore diritto, attacco PEX, multistrato e tubo rame, bocchettone autotenuta, cromato

THERMOCHROME, chrome-plated straight lockshield, PEX, multilayer and copper pipe connection, autoseal tail piece

THERMOCHROME, Gerade Rücklaufverschraubung, Anschluss für PEX, für Kupfer- und Mehrschichtrohr, mit Selbstdichtung, verchromt

THERMOCHROME, coude de réglage droit, fixation PEX, multicouche et tube en cuivre, chromé

THERMOCHROME, прямой стопорный клапан, соединение для PEX, металлопластиковой и стальной трубы. С самогерметизирующимся патрубком. хромированный.

Cod./Code	Misura/Size	Attacco/Connection	□/田	€
155505187	1/2"	24-19	1/18	





## IVR 774 CHR



A squadra, fornita con adattatore per attacco tubo ferro  
Angle, iron pipe connection  
Eckförmig, Anschluss für Eisenrohr  
Équerre, fixation tube en cuivre  
Угловой вентиль, соединение для стальной трубы

Cod./Code	Misura/Size	□/田	€
177405005	1/2"	1/15	

## IVR 561 CHR



THERMOCHROME, valvola termostattabile a squadra, fornita con adattatore per attacco tubo ferro, bocchettone autotenuta, cromata  
THERMOCHROME, chrome-plated angle thermostatic valve, iron pipe connection, autoseal tail piece  
THERMOCHROME, eckförmiges Thermostatventil, Anschluss für Eisenrohr, mit Selbstdichtung, verchromt  
THERMOCHROME, vanne thermostatisable équerre, fournie avec adaptateurs pour fixation tube en fer, raccord avec auto-étanche, chromée  
THERMOCHROME, термостатический угловой клапан, поставляется с адаптером для стальной трубы, с самогерметизирующимся патрубком. хромированный.

Cod./Code	Misura/Size	□/田	€
156105015	1/2"	1/18	

## IVR 553 CHR



THERMOCHROME, detentore a squadra, fornita con adattatore per attacco tubo ferro, bocchettone autotenuta, cromato  
THERMOCHROME, chrome-plated angle lockshield, iron pipe connection, autoseal tail piece  
THERMOCHROME, Eckrücklaufverschraubung mit Anschluss für Eisenrohr, mit Selbstdichtung, verchromt  
THERMOCHROME, coude de réglage équerre, fixation tube en fer, raccord avec auto-étanche, chromé  
THERMOCHROME, угловой стопорный клапан, поставляется с адаптером для стальной трубы, с самогерметизирующимся патрубком. хромированный.

Cod./Code	Misura/Size	□/田	€
155305015	1/2"	1/18	

## IVR 773 CHR



Dritto, fornita con adattatore per attacco tubo ferro  
Straight, iron pipe connection  
Gerade Verschraubung, Anschluss für Eisenrohr  
Droit, fixation tube fer  
Прямой вентиль, соединение для стальной трубы

Cod./Code	Misura/Size	□/田	€
177305005	1/2"	1/15	



## IVR 560 CHR



THERMOCHROME, valvola termostattizzabile diritta, fornita con adattatore per attacco tubo ferro, bocchettone autotenuta, cromata

THERMOCHROME, chrome-plated straight thermostatic valve, iron pipe connection, autoseal tail piece

THERMOCHROME, Gerade Rücklaufverschraubung mit Anschluss für Eisenrohr, mit Selbstdichtung, verchromt

THERMOCHROME, vanne thermostatisable droite, fournie avec adaptateurs pour fixation tube en fer, raccord avec auto-étanche, chromée

THERMOCHROME, термостатический прямой клапан, поставляется с адаптером для стальной трубы, с самогерметизирующимся патрубком хромированный.

Cod./Code	Misura/Size	□/田	€
156005015	1/2"	1/18	

## IVR 551 CHR



THERMOCHROME, detentore diritto, fornita con adattatore per attacco tubo ferro, bocchettone autotenuta, cromato

THERMOCHROME, chrome-plated straight lockshield, iron pipe connection, autoseal tail piece

THERMOCHROME, Gerade Rücklaufverschraubung mit Anschluss für Eisenrohr, mit Selbstdichtung, verchromt

THERMOCHROME, coude de réglage droit, fourni avec adaptateurs pour fixation tube en fer, raccord avec auto-étanche, chromé

THERMOCHROME, прямой стопорный клапан, поставляется с адаптером для стальной трубы, с самогерметизирующимся патрубком хромированный.

Cod./Code	Misura/Size	□/田	€
155105015	1/2"	1/18	

## IVR 580 CHR



Adattatori per tubo rame - Cromati

Adapters for copper pipe - Chrome

Zwischenstücke / Adapter für Kupferrohr - verchromt

Adaptateurs pour tubes en cuivre - Chromé

Фитинги для медной трубы - хромированные

Cod./Code	Misura/Size	Attacco/Connection	CH(mm)	□/田	€
158024710	10	24-19	27	10/200	
158024720	12	24-19	27	10/200	
158024740	14	24-19	27	10/200	
158024750	15	24-19	27	10/200	
158024760	16	24-19	27	10/200	

## IVR 581 CHR



Adattatori universali a compressione per tubi multistrato e polietilene reticolato PEX, nichelati - Cromati

Adapters for multilayer pipe and cross-linked polyethylene pipe PEX, nickel plated - chrome-plated

Universal-Zwischenstücke/Adapter zur Kompression für Mehrschichtrohren und Rohren aus vernetztem Polyethylen PEX - vernickelt - verchromt

Adaptateurs universels à compression pour tubes multicouche et polyéthylène réticulé PEX - nickelés - Chromé

Фитинги для многослойной трубы и труб из сшитого полиэтилена PEX, никелированные - хромированные

Cod./Code	Misura/Size	Attacco/Connection	CH(mm)	□/田	€
158124743	14 x 2	24-19	27	10/200	
158124763	16 x 2	24-19	27	10/200	
158124764	16 x 2,2	24-19	27	10/200	



## VALVOLE PER RADIATORI / RADIATOR VALVES

### Valvole termostatiche / Thermostatic valves

Testa termostatica con sensore a liquido; a bassa inerzia termica  
Thermostatic head with liquid sensor; low thermal inertia  
Thermostatkopf mit Flüssigkeitssensor; geringe thermische Trägheit  
Tête thermostatique avec capteur à liquide - à faible inertie thermique  
Термостатическая головка с жидкостным сенсором; с низкой термоинерцией

### IVR 597



Testa termostatica con sensore a liquido; a bassa inerzia termica - Bianca  
Thermostatic head with liquid sensor; low thermal inertia - White  
Thermostatkopf mit Flüssigkeitssensor; geringe thermische Trägheit - Verchromt - Weiß  
Tête thermostatique avec capteur à liquide - à faible inertie thermique - Blanc  
Термостатическая головка с жидкостным сенсором; с низкой термоинерцией - Белая

Cod./Code	Misura/Size	□/田	€
159700001	M30 x 1,5	1/50	

### IVR 599



Testa termostatica con sensore a liquido; a bassa inerzia termica - Con sensore a distanza  
Thermostatic head with liquid sensor; low thermal inertia - With remote sensor  
Thermostatkopf mit Flüssigkeitssensor; geringe thermische Trägheit. Mit Fernsensor  
Tête thermostatique avec capteur à liquide - à faible inertie thermique - Avec capteur à distance  
Термостатическая головка с жидкостным сенсором; с низкой термоинерцией - С дистанционным датчиком

Cod./Code	Misura/Size	□/田	€
159900001	M30 x 1,5	1/20	

### IVR 591



Testa termostatica con sensore a liquido a bassa inerzia termica - con sonda ad immersione  
Thermostatic head with liquid sensor at low thermal inertia - with sensor immersion sleeve  
Thermostatkopf mit Flüssigkeitssensor mit geringer thermischen Trägheit - mit Tauchsonde  
Tête thermostatique avec capteur à liquide à faible inertie thermique - avec sonde à immersion  
Термостатическая головка с жидкостным сенсором, низкой термоинерцией и погружным датчиком

Cod./Code	Misura/Size	□/田	€
159100001	M30 x 1,5	1/20	

## VALVOLE PER RADIATORI / RADIATOR VALVES

Valvole termostatiche / Thermostatic valves

SATURN - Attacco tubo ferro / Iron pipe connection

Valvola termostattabile attacco tubo ferro, bocchettone con / senza autotenuta, nichelata

Straight thermostatic valve with manual handle, iron pipe connection, with / without auto-seal tail piece; nickel plated

Thermostatventil mit Anschluss für Eisenrohr, mit /ohne Selbstdichtung - vernickelt

Vanne thermostatizable, fixation tube fer, raccord autoétanche ou non étanche - nickelée

Термостатический клапан с ручным управлением, соединение для стальной трубы, с / без самогерметизации; никелированный

### IVR 561 - IVR 561/2



**IVR 561**

**IVR 561/2**

A squadra con volantino manuale

Angle valve with manual handle

Eckförmig mit Handrad

Équerre avec volant manuel

Угловой клапан с ручным управлением

Cod./Code	Misura/Size	□/田	€
156103000	3/8"	10/60	
156105000	1/2"	10/60	
156107000	3/4"	10/40	
156103002	3/8"	10/60	(1)
156105002	1/2"	10/60	(1)
156107002	3/4"	10/40	(1)

(1) 561/2 - Art. con bocchettone senza autotenuta

(1) 561/2 - Item with tail piece without auto-seal

(1) 561/2 - Art. Ventil mit Stutzen ohne Selbstdichtung

(1) 561/2 - Art. avec raccord non étanche

(1) 561/2 - Клапан с патрубком без самогерметизации

### IVR 561/3 - IVR 561/4 PREREGOLAZIONE / PRESETTING



**IVR 561/3**

**IVR 561/4**

Con prerogolazione, a squadra con volantino manuale

Angle valve with presetting and with manual handle

Eckförmige Verschraubung mit Voreinstellung und Handrad

Avec préréglage, équerre avec volant manuel

Угловой термостатический клапан для радиаторов с преднастройкой и ручным управлением

Cod./Code	Misura/Size	□/田	€
156103003	3/8"	10/60	
156105003	1/2"	10/60	
156107003	3/4"	10/40	
156103004	3/8"	10/60	(1)
156105004	1/2"	10/60	(1)
156107004	3/4"	10/40	(1)

(1) 561/4 - Art. con bocchettone senza autotenuta

(1) 561/4 - Item with tail piece without auto-seal

(1) 561/4 - Art. Ventil mit Stutzen ohne Selbstdichtung

(1) 561/4 - Art. avec raccord non étanche

(1) 561/4 - Клапан с патрубком без самогерметизации



## IVR 567 - IVR 567/2



**IVR 567**

**IVR 567/2**

A squadra con cappello di regolazione  
Angle valve with operating plastic cap  
Eckförmige Verschraubung mit Einstellkappe  
A équerre, avec chapeau de réglage  
Угловой термостатический клапан с регулирующим колпачком

Cod./Code	Misura/Size	□/田	€
156703000	3/8"	10/120	
156705000	1/2"	10/120	
156707000	3/4"	10/60	

- (1) 567/2 - Art. con bocchettone senza autotenuta
- (1) 567/2 - Item with tail piece without auto-seal
- (1) 567/2 - Art. Ventil mit Stutzen ohne Selbstdichtung
- (1) 567/2 - Art. avec raccord non étanche
- (1) 567/2 - Клапан с патрубком без самогерметизации

156703002	3/8"	10/120	(1)
156705002	1/2"	10/120	(1)
156707002	3/4"	10/60	(1)

## IVR 567/3 - IVR 567/4 PREREGOLAZIONE / PRESETTING



**IVR 567/3**

**IVR 567/4**

Con prerregolazione, a squadra con cappello di regolazione  
Angle valve with presetting, operating plastic cap  
Eckförmige Verschraubung mit Voreinstellung und Einstellkappe  
Avec pré-réglage, équerre avec chapeau de réglage  
Угловой термостатический клапан с преднастройкой, регулирующий колпачок

Cod./Code	Misura/Size	□/田	€
156703003	3/8"	10/120	
156705003	1/2"	10/120	
156707003	3/4"	10/60	

- (1) 567/4 - Art. con bocchettone senza autotenuta
- (1) 567/4 - Item with tail piece without auto-seal
- (1) 567/4 - Art. Ventil mit Stutzen ohne Selbstdichtung
- (1) 567/4 - Art. avec raccord non étanche
- (1) 567/4 - Клапан с патрубком без самогерметизации

156703004	3/8"	10/120	(1)
156705004	1/2"	10/120	(1)
156707004	3/4"	10/60	(1)

## IVR 570 - IVR 570/2



**IVR 570**

**IVR 570/2**

Reversa con cappello di regolazione  
 Reverse angle valve with operating plastic cap  
 Echförmiges Umsteuerungsventil mit Einstellkappe  
 À corps inversé avec chapeau de réglage  
 Реверсивный угловой термостатический клапан с регулирующим колпачком

- (1) 570/2 - Art. con bocchettone senza autotenuta
- (1) 570/2 - Item with tail piece without auto-seal
- (1) 570/2 - Art. Ventil mit Stutzen ohne Selbstdichtung
- (1) 570/2 - Art. avec raccord non étanche
- (1) 570/2 - Клапан с патрубком без самогерметизации

Cod./Code	Misura/Size	□/田	€
157005000	1/2"	10/60	
157005002	1/2"	10/60	(1)

## IVR 570/3 - IVR 570/4 PREREGOLAZIONE / PRESETTING



**IVR 570/3**

**IVR 570/4**

Reversa con prerregolazione, con cappello di regolazione  
 Reverse angle valve with presetting and operating plastic cap  
 Umsteuerungsventil mit Voreinstellung, mit Einstellkappe  
 À corps inversé avec préreglage, avec chapeau de réglage  
 Реверсивный термостатический клапан с регулирующим колпачком.

- (1) 570/4 - Art. con bocchettone senza autotenuta
- (1) 570/4 - Item with tail piece without auto-seal
- (1) 570/4 - Art. Ventil mit Stutzen ohne Selbstdichtung
- (1) 570/4 - Art. avec raccord non étanche
- (1) 570/4 - Клапан с патрубком без самогерметизации

Cod./Code	Misura/Size	□/田	€
157005003	1/2"	10/60	
157005004	1/2"	10/60	(1)

## IVR 560 - IVR 560/2



**IVR 560**

**IVR 560/2**

Dritta con volantino manuale  
 Straight with manual handle  
 Gerade mit Handrad  
 Droit avec volant manuel  
 Прямой термостатический клапан с ручным управлением

- (1) 560/2 - Art. con bocchettone senza autotenuta
- (1) 560/2 - Item with tail piece without auto-seal
- (1) 560/2 - Art. Ventil mit Stutzen ohne Selbstdichtung
- (1) 560/2 - Art. avec raccord non étanche
- (1) 560/2 - Клапан с патрубком без самогерметизации

Cod./Code	Misura/Size	□/田	€
156003000	3/8"	10/60	
156005000	1/2"	10/60	
156007000	3/4"	10/40	
156003002	3/8"	10/60	(1)
156005002	1/2"	10/60	(1)
156007002	3/4"	10/40	(1)

## IVR 560/3 - IVR 560/4 PREREGOLAZIONE / PRESETTING



IVR 560/3

IVR 560/4

Con prerogolazione, dritta con volantino manuale  
Straight valve with presetting and with manual handle  
Gerade Verschraubung mit Voreinstellung und Handrad  
Avec préréglage, equerre avec volant manuel  
Прямой термостатический клапан с преднастройкой и ручным управлением

- (1) 560/4 - Art. con bocchettone senza autotenuta
- (1) 560/4 - Item with tail piece without auto-seal
- (1) 560/4 - Art. Ventil mit Stutzen ohne Selbstdichtung
- (1) 560/4 - Art. avec raccord non étanche
- (1) 560/4 - Клапан с патрубком без самогерметизации

Cod./Code	Misura/Size	□/⊞	€
156003003	3/8"	10/60	
156005003	1/2"	10/60	
156007003	3/4"	10/40	
156003004	3/8"	10/60	(1)
156005004	1/2"	10/60	(1)
156007004	3/4"	10/40	(1)

## IVR 566 - IVR 566/2



IVR 566

IVR 566/2

Dritta con cappello di regolazione  
Straight valve with operating plastic cap  
Gerade Verschraubung mit Einstellkappe  
Droite avec chapeau de réglage  
Прямой термостатический клапан с регулирующим колпачком

- (1) 566/2 - Art. con bocchettone senza autotenuta
- (1) 566/2 - Item with tail piece without auto-seal
- (1) 566/2 - Art. Ventil mit Stutzen ohne Selbstdichtung
- (1) 566/2 - Art. avec raccord non étanche
- (1) 566/2 - Клапан с патрубком без самогерметизации

Cod./Code	Misura/Size	□/⊞	€
156603000	3/8"	10/60	
156605000	1/2"	10/60	
156607000	3/4"	10/40	
156603002	3/8"	10/60	(1)
156605002	1/2"	10/60	(1)
156607002	3/4"	10/40	(1)

## IVR 566/3 - IVR 566/4 PREREGOLAZIONE / PRESETTING



IVR 566/3

IVR 566/4

Con prerogolazione, dritta con con cappello di regolazione  
Straight valve with presetting, operating plastic cap  
Gerade Verschraubung mit Voreinstellung und Einstellkappe  
Avec préréglage, droite avec chapeau de réglage  
Прямой термостатический клапан с преднастройкой и регулирующим колпачком

- (1) 566/4 - Art. con bocchettone senza autotenuta
- (1) 566/4 - Item with tail piece without auto-seal
- (1) 566/4 - Art. Ventil mit Stutzen ohne Selbstdichtung
- (1) 566/4 - Art. avec raccord non étanche
- (1) 566/4 - Клапан с патрубком без самогерметизации

Cod./Code	Misura/Size	□/⊞	€
156603003	3/8"	10/60	
156605003	1/2"	10/60	
156607003	3/4"	10/40	
156603004	3/8"	10/60	(1)
156605004	1/2"	10/60	(1)
156607004	3/4"	10/40	(1)



## VALVOLE PER RADIATORI / RADIATOR VALVES

Valvole termostatiche / Thermostatic valves

JUPITER DETENTORE/LOCKSHIELD - Attacco tubo ferro / Iron pipe connection

Detentore per valvole Saturn, attacco tubo ferro, bocchettone con/senza autotenuta, nichelata

Straight heavy lockshield for Saturn valves, iron pipe connection, with/without auto-seal tail piece, nickel plated

Rücklaufverschraubung für Saturn - Ventile, Stutzen mit/ohne Selbstdichtung, vernickelt

Coude de réglage pour vanne Saturn, fixation PEX, multicouche et tube en cuivre, raccord autoétanche ou non étanche, nickelée

Усиленный отсекающий клапан, соединение для стальной трубы, патрубок с / без самогерметизации, никелированный

### IVR 553 - IVR 553/2



IVR 553

IVR 553/2

A squadra

Angle lockshield

Eckförmige Rücklaufverschraubung

A équerre

Угловой

Cod./Code	Misura/Size	□/田	€
155303000	3/8"	10/120	
155305000	1/2"	10/120	
155307000	3/4"	10/60	
155303002	3/8"	10/120	(1)
155305002	1/2"	10/120	(1)
155307002	3/4"	10/60	(1)

(1) 553/2 - Art. con bocchettone senza autotenuta

(1) 553/2 - Item with tail piece without auto-seal

(1) 553/2 - Art. Ventil mit Stutzen ohne Selbstdichtung

(1) 553/2 - Art. avec raccord non étanche

(1) 553/2 - Клапан с патрубком без самогерметизации

### IVR 551 - IVR 551/2



IVR 551

IVR 551/2

Dritto

Straight lockshield

Gerade Rücklaufverschraubung

Droit

Прямой

Cod./Code	Misura/Size	□/田	€
155103000	3/8"	10/120	
155105000	1/2"	10/120	
155107000	3/4"	10/60	
155103002	3/8"	10/120	(1)
155105002	1/2"	10/120	(1)
155107002	3/4"	10/60	(1)

(1) 551/2 - Art. con bocchettone senza autotenuta

(1) 551/2 - Item with tail piece without auto-seal

(1) 551/2 - Art. Ventil mit Stutzen ohne Selbstdichtung

(1) 551/2 - Art. avec raccord non étanche

(1) 551/2 - Клапан с патрубком без самогерметизации

## VALVOLE PER RADIATORI / RADIATOR VALVES

### Valvole termostatiche / Thermostatic valves

#### SATURN - Attacco PEX/Rame/PEX-AL-PEX / PEX/copper/PEX-AL-PEX



Valvola termostaticizzabile, attacco PEX, multistrato e tubo rame, bocchettone autotenuta, nichelata  
Straight thermostatic valve, PEX, multilayer and copper pipe connection, auto-seal tail piece, nickel plated  
Thermostatventil, gerade, mit Anschluss für PEX, Mehrschicht und Kupferrohr, selbstdichtender Stutzen, vernickelt  
Vannes thermostatissables fixation pour tubes PEX, multicouche et en cuivre, raccord autoétanche, nickelée  
Никелированный термостатический клапан, соединение для труб: медной, PEX и многослойной, самогерметизирующий патрубок

### IVR 563 - IVR 563/2



IVR 563

IVR 563/2

A squadra con volantino manuale  
Angle valve with manual handle  
Eckförmig mit Handrad  
Equerre avec volant manuel  
Угловой клапан с ручным управлением

Cod./Code	Misura/Size	Attacco/Connection	□/田	€
156303180	3/8"	24-19	10/60	
156305180	1/2"	24-19	10/60	
156303160	3/8"	1/2"	10/60	
156305160	1/2"	1/2"	10/60	
156303182	3/8"	24-19	10/60	(1)
156305182	1/2"	24-19	10/60	(1)
156303162	3/8"	1/2"	10/60	(1)
156305162	1/2"	1/2"	10/60	(1)

- (1) 563/2 - Art. con bocchettone senza autotenuta
- (1) 563/2 - Item with tail piece without auto-seal
- (1) 563/2 - Art. Ventil mit Stutzen ohne Selbstdichtung
- (1) 563/2 - Art. avec raccord non étanche
- (1) 563/2 - Клапан с патрубком без самогерметизации

### IVR 563/3 - IVR 563/4 PREREGOLAZIONE / PRESETTING



IVR 563/3

IVR 563/4

Con prerregolazione, a squadra con volantino manuale  
Angle valve with presetting and with manual handle  
Eckförmige Verschraubung mit Voreinstellung und Handrad  
Avec préréglage, équerre avec volant manuel  
Угловой клапан для радиаторов с преднастройкой и ручным управлением

Cod./Code	Misura/Size	Attacco/Connection	□/田	€
156303183	3/8"	24-19	10/60	
156305183	1/2"	24-19	10/60	
156303163	3/8"	1/2"	10/60	
156305163	1/2"	1/2"	10/60	
156303184	3/8"	24-19	10/60	(1)
156305184	1/2"	24-19	10/60	(1)
156303164	3/8"	1/2"	10/60	(1)
156305164	1/2"	1/2"	10/60	(1)

- (1) 563/4 - Art. con bocchettone senza autotenuta
- (1) 563/4 - Item with tail piece without auto-seal
- (1) 563/4 - Art. Ventil mit Stutzen ohne Selbstdichtung
- (1) 563/4 - Art. avec raccord non étanche
- (1) 563/4 - Клапан с патрубком без самогерметизации

## IVR 569 - IVR 569/2



**IVR 569**

**IVR 569/2**

A squadra con cappello di regolazione  
 Angle valve with operating plastic cap  
 Eckförmige Verschraubung mit Einstellkappe  
 A équerre, avec chapeau de réglage  
 Угловой клапан с регулирующим колпачком

Cod./Code	Misura/Size	Attacco/Connection	□/田	€
156903180	3/8"	24-19	10/60	
156905180	1/2"	24-19	10/60	
156903160	3/8"	1/2"	10/60	
156905160	1/2"	1/2"	10/60	
156903182	3/8"	24-19	10/60	(1)
156905182	1/2"	24-19	10/60	(1)
156903162	3/8"	1/2"	10/60	(1)
156905162	1/2"	1/2"	10/60	(1)

- (1) 569/2 - Art. con bocchettone senza autotenuta  
 (1) 569/2 - Item with tail piece without auto-seal  
 (1) 569/2 - Art. Ventil mit Stutzen ohne Selbstdichtung  
 (1) 569/2 - Art. avec raccord non étanche  
 (1) 569/2 - Клапан с патрубком без самогерметизации

## IVR 569/3 - IVR 569/4 PREREGOLAZIONE / PRESETTING



**IVR 569/3**

**IVR 569/4**

Con prerregolazione, a squadra con cappello di regolazione  
 Angle valve with presetting, operating plastic cap  
 Eckförmige Verschraubung mit Voreinstellung und Einstellkappe  
 Avec pré-réglage, équerre avec chapeau de réglage  
 Угловой клапан с преднастройкой и регулирующим колпачком

Cod./Code	Misura/Size	Attacco/Connection	□/田	€
156903183	3/8"	24-19	10/120	
156905183	1/2"	24-19	10/120	
156903163	3/8"	1/2"	10/120	
156905163	1/2"	1/2"	10/120	
156903184	3/8"	24-19	10/120	(1)
156905184	1/2"	24-19	10/120	(1)
156903164	3/8"	1/2"	10/120	(1)
156905164	1/2"	1/2"	10/120	(1)

- (1) 569/4 - Art. con bocchettone senza autotenuta  
 (1) 569/4 - Item with tail piece without auto-seal  
 (1) 569/4 - Art. Ventil mit Stutzen ohne Selbstdichtung  
 (1) 569/4 - Art. avec raccord non étanche  
 (1) 569/4 - Клапан с патрубком без самогерметизации

## IVR 571 - IVR 571/2



**IVR 571**

**IVR 571/2**

Reversa con cappello di regolazione  
 Reverse angle valve with operating plastic cap  
 Eckförmiges Umsteuerungsventil mit Einstellkappe  
 À corps inversé avec chapeau de réglage  
 Реверсивный угловой клапан с регулирующим колпачком

Cod./Code	Misura/Size	Attacco/Connection	□/田	€
157105180	1/2"	24-19	10/60	
157105182	1/2"	24-19	10/60	(1)

- (1) 571/2 - Art. con bocchettone senza autotenuta  
 (1) 571/2 - Item with tail piece without auto-seal  
 (1) 571/2 - Art. Ventil mit Stutzen ohne Selbstdichtung  
 (1) 571/2 - Art. avec raccord non étanche  
 (1) 571/2 - Клапан с патрубком без самогерметизации

## IVR 571/3 - IVR 571/4

NEW



IVR 571/3

IVR 571/4

Reversa con preregolazione, con cappello di regolazione  
Reverse valve with presetting and operating plastic cap  
Umsteuerungsventil mit Voreinstellung, mit Einstellkappe  
À corps inversé avec préreglage, avec chapeau de réglage  
Реверсивный термостатический клапан с регулирующим колпачком.

- (1) 571/4 - Art. con bocchettone senza autotenuta
- (1) 571/4 - Item with tail piece without auto-seal
- (1) 571/4 - Art. Ventil mit Stutzen ohne Selbstdichtung
- (1) 571/4 - Art. avec raccord non étanche
- (1) 571/4 - Клапан с патрубком без самогерметизации

Cod./Code	Misura/Size	Attacco/Connection	□/田	€
157105183	1/2"	24-19	10/60	
157105184	1/2"	24-19	10/60	(1)

## IVR 562 - IVR 562/2



IVR 562

IVR 562/2

Dritta con volantino manuale  
Straight with manual handle  
Gerade mit Handrad  
Droit avec volant manuel  
Прямой клапан с ручным управлением

- (1) 562/2 - Art. con bocchettone senza autotenuta
- (1) 562/2 - Item with tail piece without auto-seal
- (1) 562/2 - Art. Ventil mit Stutzen ohne Selbstdichtung
- (1) 562/2 - Art. avec raccord non étanche
- (1) 562/2 - Клапан с патрубком без самогерметизации

Cod./Code	Misura/Size	Attacco/Connection	□/田	€
156203180	3/8"	24-19	10/60	
156205180	1/2"	24-19	10/60	
156203160	3/8"	1/2"	10/60	
156205160	1/2"	1/2"	10/60	
156203182	3/8"	24-19	10/60	(1)
156205182	1/2"	24-19	10/60	(1)
156203162	3/8"	1/2"	10/60	(1)
156205162	1/2"	1/2"	10/60	(1)

## IVR 562/3 - IVR 562/4 PREREGOLAZIONE / PRESETTING



IVR 562/3

IVR 562/4

Con preregolazione, dritta con volantino manuale  
Straight valve with presetting and with manual handle  
Gerade Verschraubung mit Voreinstellung und Handrad  
Avec préreglage, equerre avec volant manuel  
Прямой клапан для радиаторов с преднастройкой и ручным управлением

- (1) 562/4 - Art. con bocchettone senza autotenuta
- (1) 562/4 - Item with tail piece without auto-seal
- (1) 562/4 - Art. Ventil mit Stutzen ohne Selbstdichtung
- (1) 562/4 - Art. avec raccord non étanche
- (1) 562/4 - Клапан с патрубком без самогерметизации

Cod./Code	Misura/Size	Attacco/Connection	□/田	€
156203183	3/8"	24-19	10/60	
156205183	1/2"	24-19	10/60	
156203163	3/8"	1/2"	10/60	
156205163	1/2"	1/2"	10/60	
156203184	3/8"	24-19	10/60	(1)
156205184	1/2"	24-19	10/60	(1)
156203164	3/8"	1/2"	10/60	(1)
156205164	1/2"	1/2"	10/60	(1)

## IVR 568 - IVR 568/2



Dritta con cappello di regolazione  
 Straight valve with operating plastic cap  
 Gerade Verschraubung mit Einstellkappe  
 Droite avec chapeau de réglage  
 Прямой клапан с регулирующим колпачком

Cod./Code	Misura/Size	Attacco/Connection	□/田	€
156803180	3/8"	24-19	10/60	
156805180	1/2"	24-19	10/60	
156803160	3/8"	1/2"	10/60	
156805160	1/2"	1/2"	10/60	

(1) 568/2 - Art. con bocchettone senza autotenuta  
 (1) 568/2 - Item with tail piece without auto-seal  
 (1) 568/2 - Art. Ventil mit Stutzen ohne Selbstdichtung  
 (1) 568/2 - Art. avec raccord non étanche  
 (1) 568/2 - Клапан с патрубком без самогерметизации

156803182	3/8"	24-19	10/60	(1)
156805182	1/2"	24-19	10/60	(1)
156803162	3/8"	1/2"	10/60	(1)
156805162	1/2"	1/2"	10/60	(1)

## IVR 568/3 - IVR 568/4 PREREGOLAZIONE / PRESETTING



**IVR 568/3**

**IVR 568/4**

Con prerogolazione, dritta con con cappello di regolazione  
 Straight valve with presetting, operating plastic cap  
 Gerade Verschraubung mit Voreinstellung und Einstellkappe  
 Avec pré-réglage, droite avec chapeau de réglage  
 Прямой клапан с преднастройкой, регулирующий колпачок

Cod./Code	Misura/Size	Attacco/Connection	□/田	€
156803183	3/8"	24-19	10/60	
156805183	1/2"	24-19	10/60	
156803163	3/8"	1/2"	10/60	
156805163	1/2"	1/2"	10/60	

(1) 568/4 - Art. con bocchettone senza autotenuta  
 (1) 568/4 - Item with tail piece without auto-seal  
 (1) 568/4 - Art. Ventil mit Stutzen ohne Selbstdichtung  
 (1) 568/4 - Art. avec raccord non étanche  
 (1) 568/4 - Клапан с патрубком без самогерметизации

156803184	3/8"	24-19	10/60	(1)
156805184	1/2"	24-19	10/60	(1)
156803164	3/8"	1/2"	10/60	(1)
156805164	1/2"	1/2"	10/60	(1)

## VALVOLE PER RADIATORI / RADIATOR VALVES

### Valvole termostatiche / Thermostatic valves

#### SATURN-COAXIAL

#### Attacco Tubo Ferro



Valvola coassiale termostattizzabile per radiatori con volantino manuale. Attacchi tubo ferro. Bocchettone con autotenuta. Impieghi: adatte per utilizzo su ogni tipo di radiatore  
Thermostatic coaxial valve with plastic cap, iron pipe connection, tail piece with auto-seal. Use: suitable for any type of radiator  
Koaxial-Thermostatventil für Heizkörper mit Handrad. Anschlussstutzen mit Selbstdichtung für Eisenrohr. Sie können auf jede Sorte von Heizkörper eingesetzt werden  
Vanne coaxiale thermostatizable pour radiateurs avec volant manuel. Fixation tube fer. Raccord avec auto-étanche. Usage: adapté à tout type de radiateur  
Коаксиальный термостатический радиаторный клапан с регулирующим пластиковым колпачком. Соединение для стальной трубы. Самогерметизирующийся патрубков. Сфера применения: может устанавливаться на любой тип радиатора

### IVR 530 - IVR 530/2



3 vie, attacco tubo ferro, con cappellino di regolazione e autotenuta  
3 ways, iron pipe connections, with operating plastic cap and auto-seal  
3 Wege, Anschluss für Eisenrohr, mit Einstellkappe und Selbstdichtung  
3 voies, fixation tube fer, avec chapeau de réglage et auto-étanche  
Трехходовой, соединение для стальной трубы, с регулирующим колпачком и самогерметизацией

- (1) 530/2 - Con bocchettone senza autotenuta
- (1) 530/2 - Item with tail piece without auto-seal
- (1) 530/2 - Artikel Ventil mit rohverschraubung ohne Selbstdichtung
- (1) 530/2 - Article avec raccord sans étanche
- (1) 530/2 - с накидной гайкой без самогерметизации

Cod./Code	Misura/Size	□/田	€
153003000	3/8"	10/60	
153005000	1/2"	10/40	
153003002	3/8"	10/60	(1)
153005002	1/2"	10/40	(1)

### IVR 530 AD



Adattatore per tubo PEX/Rame/PEX-AL-PEX  
Adapter for PEX, multilayer and copper pipe  
PEX, Kupferrohr und Mehrschichtrohr Anschlussadapter  
Adaptateur pour tube PEX, multi-couches ou cuivre.  
Адаптер для труб: металлопластиковой, медной и PEX

Cod./Code	Misura/Size	Attacco/Connection	□/田	€
153003024	3/8"	24-19	10/120	
153005024	1/2"	24-19	10/120	



## VALVOLE PER RADIATORI / RADIATOR VALVES

Valvole termostatiche / Thermostatic valves

JUPITER DETENTORE/LOCKSHIELD - Attacco PEX/Rame/PEX-AL-PEX / PEX/copper/PEX-AL-PEX

Detentore, attacco PEX, multistrato e tubo rame, bocchettone autotenuta, nichelato

Heavy lockshield, PEX, multilayer and copper pipe connection, auto-seal tail piece, nickel plated

Rücklaufverschraubung PEX, Mehrschicht- und Kupferrohr-Anschluss, selbstdichtender Stutzen, vernickelt

Coude de réglage, fixation PEX, multicouche et tube en cuivre, raccord autoétanche, nickelé

Усиленный отсекающий клапан; соединения для трубы PEX, медной и многослойной труб, патрубок с самогерметизацией, никелированный

### IVR 557 - IVR 557/2



IVR 557

IVR 557/2

A squadra  
 Angle lockshield  
 Eckförmige Rücklaufverschraubung  
 A équerre  
 Угловой

Cod./Code	Misura/Size	Attacco/Connection	□/田	€
155703180	3/8"	24-19	10/120	
155705180	1/2"	24-19	10/120	
155703160	3/8"	1/2"	10/120	
155705160	1/2"	1/2"	10/120	
155703182	3/8"	24-19	10/120	(1)
155705182	1/2"	24-19	10/120	(1)
155703162	3/8"	1/2"	10/120	(1)
155705162	1/2"	1/2"	10/120	(1)

(1) 557/2 - Art. con bocchettone senza autotenuta

(1) 557/2 - Item with tail piece without auto-seal

(1) 557/2 - Art. Ventil mit Stutzen ohne Selbstdichtung

(1) 557/2 - Art. avec raccord non étanche

(1) 557/2 - Клапан с патрубком без самогерметизации

### IVR 555 - IVR 555/2



IVR 555

IVR 555/2

Dritto  
 Straight lockshield  
 Gerade Rücklaufverschraubung  
 Droit  
 Прямой

Cod./Code	Misura/Size	Attacco/Connection	□/田	€
155503180	3/8"	24-19	10/60	
155505180	1/2"	24-19	10/60	
155503160	3/8"	1/2"	10/60	
155505160	1/2"	1/2"	10/60	
155503182	3/8"	24-19	10/60	(1)
155505182	1/2"	24-19	10/60	(1)
155503162	3/8"	1/2"	10/60	(1)
155505162	1/2"	1/2"	10/60	(1)

(1) 555/2 - Art. con bocchettone senza autotenuta

(1) 555/2 - Item with tail piece without auto-seal

(1) 555/2 - Art. Ventil mit Stutzen ohne Selbstdichtung

(1) 555/2 - Art. avec raccord non étanche

(1) 555/2 - Клапан с патрубком без самогерметизации

## KIT TERMOSTATICI / THERMOSTATIC KITS



Kit termostatico composto da valvola Saturn, detentore Jupiter e testa termostatica a liquido Sunny

Thermostatic kit: Saturn valve, Jupiter lockshield and Sunny thermostatic head with liquid sensor

Gruppe bestehend aus Thermostatventil Saturn, Rücklaufverschraubung Jupiter und thermostatischem Kopf Sunny

Kit thermostatique composé de vanne Saturn, coude de réglage Jupiter et tête thermostatique avec capteur liquide Sunny

Термостатический комплект состоящий из клапана Saturn, отсекающего вентиля Jupiter и термостатической головки Sunny с жидкостным сенсором.

### IVR 567 KIT

NEW



A squadra, per attacco tubo ferro

Angle, iron pipe connection

Eckförmig, Anschluss für Eisenrohr

Équerre, fixation tube en fer

Угловой вентиль, соединение для железной трубы

Cod./Code	Misura/Size	□/田	€
1567K03000	3/8"	1/15	
1567K05000	1/2"	1/15	
1567K07000	3/4"	1/15	

### IVR 566 KIT

NEW



Dritto, per attacco tubo ferro

Straight, iron pipe connection

Gerade, Anschluss für Eisenrohr

Droit, fixation tube en fer

Прямой вентиль, соединение для железной трубы

Cod./Code	Misura/Size	□/田	€
1566K03000	3/8"	1/15	
1566K05000	1/2"	1/15	
1566K07000	3/4"	1/15	

### IVR 569 KIT

NEW



A squadra, attacco tubo rame, PEX e multiestrato

Angle, PEX, multilayer and copper pipe connection

Eckförmig, Anschluss für Kupfer, PEX und Mehrschichtrohr

Équerre, fixation tube en cuivre, PEX et multicouche

Угловой вентиль, соединение для медной, PEX и многослойной трубы

Cod./Code	Misura/Size	Attacco/Connection	□/田	€
1569K03160	3/8"	1/2"	1/15	
1569K05160	1/2"	1/2"	1/15	
1569K03180	3/8"	24-19	1/15	
1569K05180	1/2"	24-19	1/15	

### IVR 568 KIT

NEW



Dritto, attacco tubo rame, PEX e multistrato

Straight, PEX, multilayer and copper pipe connection

Gerade, Anschluss für Kupfer, PEX und Mehrschichtrohr

Droit, fixation tube en cuivre, PEX et multicouche

Прямой вентиль, соединение для медной, PEX и многослойной трубы

Cod./Code	Misura/Size	Attacco/Connection	□/田	€
1568K03160	3/8"	1/2"	1/15	
1568K05160	1/2"	1/2"	1/15	
1568K03180	3/8"	24-19	1/15	
1568K05180	1/2"	24-19	1/15	

## IVR 570 KIT

**NEW**



A squadra, per attacco tubo ferro  
 Angle, iron pipe connection  
 Eckförmig, Anschluss für Eisenrohr  
 Équerre, fixation tube en fer  
 Угловой вентиль, соединение для железной трубы

Cod./Code	Misura/Size	□/田	€
1570K05000	1/2"	1/15	

## IVR 571 KIT

**NEW**



A squadra, attacco tubo rame, PEX e multistrato  
 Angle, PEX, multilayer and copper pipe connection  
 Eckförmig, Anschluss für Kupfer, PEX und Mehrschichtrohr  
 Équerre, fixation tube en cuivre, PEX et multicouche  
 Угловой вентиль, соединение для медной, PEX и многослойной трубы

Cod./Code	Misura/Size	Attacco/Connection	□/田	€
1571K05180	1/2"	24-19	1/15	

## IVR 436



Kit valvole termostattizzabili a squadra per tubo rame, PEX e multistrato, composto da: valvola SATURN e detentore JUPITER, volantino manuale, 2+2 DX/SX riduzioni con guarnizione, valvola scarico aria, tappo ottone con cappuccio bianco

Thermostatic angle radiator valve kit for copper, PEX and multilayer pipe, includes: SATURN radiator valve and JUPITER lockshield, manual handle, 2+2 DX/SX reductions, manual air vent valve, brass plug with white plastic cap

KIT (Garnitur) Thermostatventile, eckförmig für Kupfer-, PEX- und Mehrschichtrohr, bestehend aus: Ventil SATURN und Rücklaufverschraubung JUPITER, Handrad, 2+2 Reduzierstücke rechts/links mit Dichtung, Entlüftungsventil, Messingdeckel mit weißer Kappe

Kit vannes thermostatisables équerre pour tube en cuivre, PEX et multicouche, composé de: vanne SATURN et coude de réglage JUPITER, volant manuel, 2+2 DX/SX réductions avec joint, vanne évacuation aria, bouchon en laiton avec capuchon blanc

Комплект термостатических угловых клапанов для медной, многослойной и трубы PEX включает: радиаторный клапан Saturn и отсекающий клапан Jupiter, 2 + 2 пр./лев. футорки с прокладками, ручной воздухоотводчик, заглушки из латуни с белым пластиковыми колпачками

Cod./Code	Misura/Size	Attacco/Connection	□/田	€
143603682	3/8"	24-19	1/7	
143605682	1/2"	24-19	1/7	

## VALVOLE TERMOSTATICHE / THERMOSTATIC VALVES

Componenti e ricambi / Components and spare parts



### IVR 458



Vitone per valvola termostatica

TRV bonnet

Einsatz für Thermostatventil im Verteiler

Mécanisme pour robinetterie thermostatisable

Вставка для термостатического клапана

Cod./Code	Misura/Size		□/⊞	€
228500005	3/8"-1/2"		20/300	
228500006	3/4"		20/300	
228500115	3/8"-1/2"	PREREG. / PRESET	20/300	
228500117	3/4"	PREREG. / PRESET	20/300	
228500155	3/8"-1/2"	FLUSSO INVERSO / REVERSE FLOW	20/300	
228500157	3/4"	FLUSSO INVERSO / REVERSE FLOW	20/300	
228500165	3/8"-1/2"	PREREG.-FLUSSO INVERSO / PRESET-REVERSE FLOW	20/300	
228500167	3/4"	PREREG.-FLUSSO INVERSO / PRESET-REVERSE FLOW	20/300	

### IVR 459



Chiave per sostituire vitone

Allen key for bonnets replacement

Montageblock für den Austausch (von Thermostatventil-Innenteilen unter Druck)

Clef pour changement du mécanisme

Ключ для замены кран-бухсы без слива системы

Cod./Code	Misura/Size	□/⊞	€
338300171		1	

## IVR 457



Adattatore per montaggio testa termostatica DNF  
 Adapter for mounting DNF thermostatic head  
 Adapter für den Thermostatkopf DNF  
 Adaptateur pour le montage de la tête thermostatique DNF  
 Адаптер для монтажа термостатической головки DNF

Cod./Code	Misura/Size	□/田	€
145700500		10/180	

## IVR 324



Bocchettone per Saturn e Mercury - Con autotenuta  
 Tail piece for Saturn e Mercury - with auto-seal  
 Rohrverschraubung für Saturn und Mercury - mit Selbstdichtung  
 Raccord pour Saturn et Mercury - avec autoétanche  
 Самогерметизирующий патрубок для моделей Saturn и Mercury

Cod./Code	Misura/Size	□/田	€
132403051	3/8" x 1/2"	20/240	
132405071	1/2" x 3/4"	20/240	
132407101	3/4" x 1"	10/120	

## IVR 326



Bocchettone per Saturn e Mercury senza autotenuta - (codolo + calotta)  
 Tail piece for Saturn e Mercury with auto-seal (tail piece and nut)  
 Rohrverschraubung für Saturn und Mercury mit Selbstdichtung (Verschraubung und Nuss)  
 Raccord pour Saturn et Mercury avec autoétanche (queue et calotte)  
 Патрубок без самогерметизации для моделей Saturn и Mercury (хвостовая часть с гайкой)

Cod./Code	Misura/Size	□/田	€
132603051	3/8" x 1/2"	20/240	
132605071	1/2" x 3/4"	20/240	
132607101	3/4" x 1"	10/120	
132610121	1" x 1"1/4"	10/160	

## IVR 325



Bocchettone telescopico, nichelato  
 Telescopic tail piece, nickel-plated  
 Anschluss-Stutzen teleskopisch - vernickelt  
 Raccord télescopique - nickelé  
 Телескопическое соединение, никелированное

Cod./Code	Misura/Size	□/田	€
132503051	3/8"	20/400	
132505071	1/2"	10/200	
132507101	3/4"	5/100	



## IVR 594



Volantino manuale. ABS colore RAL 9010 - per SATURN, AVANT FLOOR, IVR INOX  
Manual handle. ABS Ral 9010 colour - for SATURN, AVANT FLOOR, IVR INOX  
ABS Handrad, RAL9010 - für SATURN, AVANT FLOOR, IVR INOX  
Volant manuel ABS couleur RAL 9010 - pour SATURN, AVANT FLOOR, IVR INOX  
Колпачок для ручной регулировки, ABS цвет Ral 9010 - для SATURN, AVANT FLOOR, IVR INOX.

Cod./Code	Misura/Size	□/田	€
159400001		10/120	

## IVR 596



Cappello di regolazione per SATURN, AVANT FLOOR, IVR INOX - ABS Colore RAL 9010  
Operating plastic cap for SATURN, AVANT FLOOR, IVR INOX - ABS Ral 9010 colour  
ABS Einstellkappe für SATURN, AVANT FLOOR, IVR INOX - RAL 9010  
Chapeau de réglage pour SATURN, AVANT FLOOR, IVR INOX - ABS Couleur RAL 9010  
Регулирующий колпачок для SATURN, AVANT FLOOR, IVR INOX - ABS цвет Ral 9010

Cod./Code	Misura/Size	□/田	€
159600001	M30 x 1.5	10/180	

## IVR 588



Cappuccio per detentori JUPITER - ABS colore RAL 9010  
Plug for lockshield JUPITER - ABS colour Ral 9010  
Kappe für Rücklaufverschraubungen JUPITER - ABS RAL 9010  
Capuchon pour coudes de réglages JUPITER - ABS couleur RAL 9010  
Колпачок для отсекающего клапана JUPITER - ABS цвет RAL 9010

Cod./Code	Misura/Size	□/田	€
158803001	3/8"	10/180	
158805001	1/2"	10/180	
158805001	3/4"	10/120	

## IVR 595



Anello anti manomissione  
Anti-temper ring  
Ring - abschließbar  
Anneau contre sabotage  
Защитное кольцо

Cod./Code	Misura/Size	□/田	€
159500001	M30 x 1,5	1/20	



## VALVOLE PER RADIATORI / RADIATOR VALVES

Valvole manuali / Manuale valves

MERCURY - Attacco tubo ferro / Iron pipe connection

Valvola manuale per radiatori, attacco tubo ferro, bocchettone con/senza autotenuta, nichelata  
 Manual radiator valve, iron pipe connection, with/without auto-seal tail piece, nickel plated  
 Manuelles Heizkörperventil, Anschluss für Eisenrohr, Stutzen mit/ohne Selbstdichtung - vernickelt  
 Robinet manuel pour radiateurs, fixation tube fer, raccord autoétanche ou non étanche - nickelée  
 Ручной радиаторный клапан, соединение для стальной трубы, с патрубком с/без самогерметизации

### IVR 536 - IVR 536/2



IVR 536

IVR 536/2

A squadra con volantino manuale  
 Angle valve with manual handle  
 Eckförmig mit Handrad  
 Equerre avec volant manuel  
 Угловой клапан с ручным управлением

Cod./Code	Misura/Size	□/田	€
153603000	3/8"	10/60	
153605000	1/2"	10/60	
153607000	3/4"	10/60	
153603002	3/8"	10/60	(1)
153605002	1/2"	10/60	(1)
153607002	3/4"	10/60	(1)

(1) 536/2 - Art. con bocchettone senza autotenuta  
 (1) 536/2 - Item with tail piece without auto-seal  
 (1) 536/2 - Art. Ventil mit Stutzen ohne Selbstdichtung  
 (1) 536/2 - Art. avec raccord non étanche  
 (1) 536/2 - Клапан с патрубком без самогерметизации

### IVR 534 - IVR 534/2



IVR 534

IVR 534/2

Dritta con volantino manuale  
 Straight with manual handle  
 Gerade mit Handrad  
 Droit avec Volant manuel  
 Прямой клапан с ручным управлением

Cod./Code	Misura/Size	□/田	€
153403000	3/8"	10/60	
153405000	1/2"	10/60	
153407000	3/4"	10/60	
153403002	3/8"	10/60	(1)
153405002	1/2"	10/60	(1)
153407002	3/4"	10/60	(1)

(1) 534/2 - Art. con bocchettone senza autotenuta  
 (1) 534/2 - Item with tail piece without auto-seal  
 (1) 534/2 - Art. Ventil mit Stutzen ohne Selbstdichtung  
 (1) 534/2 - Art. avec raccord non étanche  
 (1) 534/2 - Клапан с патрубком без самогерметизации

## VALVOLE PER RADIATORI / RADIATOR VALVES

### Valvole manuali / Manuale valves

#### MERCURY - Detentore attacco tubo ferro / Lockshield iron pipe connection



Detentore per radiatori, attacco tubo ferro, bocchettone con/senza autotenuta, nichelato  
Lockshield, iron pipe connection, with/without auto-seal tail piece, nickel plated  
Rücklaufverschraubung für Heizkörper, Anschluss für Eisenrohr, Stutzen mit/ohne Selbstdichtung, vernickelt  
Coudes de réglages pour radiateurs, fixation tube fer, raccord autoétanche ou non étanche, nickelée  
Отсекающий клапан для радиаторов, соединения для стальной трубы, патрубок с/без уплотнения, никелированный

### IVR 537 - IVR 537/2



IVR 537

IVR 537/2

A squadra, con autotenuta  
Angle valve with auto-seal tail piece  
Eckförmig und selbstdichtend  
A équerre avec autoétanche  
Угловой клапан, патрубок с самогерметизацией

Cod./Code	Misura/Size	□/⊕	€
153703000	3/8"	10/120	
153705000	1/2"	10/120	
153707000	3/4"	10/60	
153703002	3/8"	10/120	(1)
153705002	1/2"	10/120	(1)
153707002	3/4"	10/60	(1)

- (1) 537/2 - Art. con bocchettone senza autotenuta
- (1) 537/2 - Item with tail piece without auto-seal
- (1) 537/2 - Art. Ventil mit Stutzen ohne Selbstdichtung
- (1) 537/2 - Art. avec raccord non étanche
- (1) 537/2 - Клапан с патрубком без самогерметизации

### IVR 535 - IVR 535/2



IVR 535

IVR 535/2

Dritto, con autotenuta  
Straight, with auto-seal tail piece  
Gerade und selbstdichtend  
Droite, avec autoétanche  
Прямой отсекающий клапан с самогерметизацией

Cod./Code	Misura/Size	□/⊕	€
153503000	3/8"	10/120	
153505000	1/2"	10/120	
153507000	3/4"	10/60	
153503002	3/8"	10/120	(1)
153505002	1/2"	10/120	(1)
153507002	3/4"	10/60	(1)

- (1) 535/2 - Art. con bocchettone senza autotenuta
- (1) 535/2 - Item with tail piece without auto-seal
- (1) 535/2 - Art. Ventil mit Stutzen ohne Selbstdichtung
- (1) 535/2 - Art. avec raccord non étanche
- (1) 535/2 - Клапан с патрубком без самогерметизации

## VALVOLE PER RADIATORI / RADIATOR VALVES

Valvole manuali / Manuale valves

MERCURY PLUS - Ispezionabili/Unscrewable - Attacco tubo ferro / Iron pipe connection

Valvola ispezionabile manuale a squadra per radiatori, attacco tubo ferro, bocchettone con/senza autotenuta, nichelata  
 Angle manual radiators valve, iron pipe connection, with/without auto-seal tail piece, nickel plated  
 Eckförmiges inspektionierbar manuelles Heizkörperventil, Anschluss für Eisenrohr, Stutzen mit/ohne Selbstdichtung, vernickelt  
 Vanne contrôlable manuelle équerre pour radiateurs, fixation à souder pour tube en cuivre, raccord autoétanche ou non étanche, nickelée  
 Ручной радиаторный клапан, соединение для стальной трубы, патрубков с/без самогерметизации, никелированный

### IVR 548 - IVR 548/2



**IVR 548**

**IVR 548/2**

A squadra con volantino manuale  
 Angle valve with manual handle  
 Eckförmig mit Handrad  
 Equerre avec volant manuel  
 Угловой клапан с ручным управлением

(1) 548/2 - Art. con bocchettone senza autotenuta  
 (1) 548/2 - Item with tail piece without auto-seal  
 (1) 548/2 - Art. Ventil mit Stutzen ohne Selbstdichtung  
 (1) 548/2 - Art. avec raccord non étanche  
 (1) 548/2 - Клапан с патрубком без самогерметизации

Cod./Code	Misura/Size	□/田	€
154805000	1/2"	10/60	
154807000	3/4"	10/60	
154805002	1/2"	10/60	(1)
154807002	3/4"	10/60	(1)

### IVR 546 - IVR 546/2



**IVR 546**

**IVR 546/2**

Dritta con volantino manuale  
 Straight with manual handle  
 Gerade mit Handrad  
 Droit avec volant manuel  
 Прямой клапан с ручным управлением

(1) 546/2 - Art. con bocchettone senza autotenuta  
 (1) 546/2 - Item with tail piece without auto-seal  
 (1) 546/2 - Art. Ventil mit Stutzen ohne Selbstdichtung  
 (1) 546/2 - Art. avec raccord non étanche  
 (1) 546/2 - Клапан с патрубком без самогерметизации

Cod./Code	Misura/Size	□/田	€
154605000	1/2"	10/60	
154607000	3/4"	10/60	
154605002	1/2"	10/60	(1)
154607002	3/4"	10/60	(1)

## VALVOLE PER RADIATORI / RADIATOR VALVES

### Valvole manuali / Manuale valves

#### MERCURY PLUS - Detentore attacco tubo ferro / Lockshield iron pipe connection



Detentore ispezionabile a squadra per radiatori, attacco tubo ferro, bocchettone con/senza autotenuta, nichelata  
Angle lockshield, iron pipe connection, with/without auto-seal tail piece, nickel plated  
Eckförmiges Rücklaufverschraubung, inspektionierbar, für Heizkörper, Anschluss für Kupferrohr, Stutzen mit/ohne Selbstdichtung, vernickelt  
Coude de réglage controlable étanche, fixation à souder pour tube en cuivre, raccord autoétanche ou non étanche, nickelée  
Отсекающий угловой клапан, соединения для стальной трубы, патрубком с / без самогерметизации, никелированный

### IVR 549 - IVR 549/2



A squadra  
Angle lockshield  
Eckförmige Rücklaufverschraubung  
A équerre  
Угловой клапан

**IVR 549**

**IVR 549/2**

- (1) 549/2 - Art. con bocchettone senza autotenuta
- (1) 549/2 - Item with tail piece without auto-seal
- (1) 549/2 - Art. Ventil mit Stutzen ohne Selbstdichtung
- (1) 549/2 - Art. avec raccord non étanche
- (1) 549/2 - Клапан с патрубком без самогерметизации

Cod./Code	Misura/Size	□/⊞	€
154905000	1/2"	10/120	
154907000	3/4"	10/60	
154905002	1/2"	10/120	(1)
154907002	3/4"	10/60	(1)

### IVR 547 - IVR 547/2



Dritto  
Straight lockshield  
Gerade Rücklaufverschraubung  
Droit  
Прямой клапан

**IVR 547**

**IVR 547/2**

- (1) 547/2 - Art. con bocchettone senza autotenuta
- (1) 547/2 - Item with tail piece without auto-seal
- (1) 547/2 - Art. Ventil mit Stutzen ohne Selbstdichtung
- (1) 547/2 - Art. avec raccord non étanche
- (1) 547/2 - Клапан с патрубком без самогерметизации

Cod./Code	Misura/Size	□/⊞	€
154705000	1/2"	10/120	
154707000	3/4"	10/60	
154705002	1/2"	10/120	(1)
154707002	3/4"	10/60	(1)

## VALVOLE PER RADIATORI / RADIATOR VALVES

Valvole manuali / Manuale valves

MERCURY - Attacco PEX/Rame/PEX-AL-PEX / PEX/copper/PEX-AL-PEX

Valvola manuale per radiatori, attacco PEX, multistrato e tubo rame, bocchettone con/senza autotenuta, nichelata  
 Manual valve for radiators, PEX, multilayer and copper pipe connection, tail piece with/without auto-seal, nickel-plated  
 Handventil für Heizkörper, PEX, Mehrschicht- und Kupferrohr-Anschluss, Rohrverschraubung mit/ohne Selbstdichtung, vernickelt  
 Vanne manuelle pour radiateurs, fixation PEX, multicouche et tube en cuivre, raccord avec/sans auto-étanche, nickelée  
 Ручной радиаторный клапан, соединения для: PEX, многослойной и медной трубы, патрубок с / без самогерметизации, никелированный

### IVR 540 - IVR 540/2



IVR 540

IVR 540/2

- (1) 540/2 - Art. con bocchettone senza autotenuta
- (1) 540/2 - Item with tail piece without auto-seal
- (1) 540/2 - Art. Ventil mit Stutzen ohne Selbstdichtung
- (1) 540/2 - Art. avec raccord non étanche
- (1) 540/2 - Клапан с патрубком без самогерметизации

A squadra con volantino manuale  
 Angle valve with manual handle  
 Eckförmig mit Handrad  
 Equerre avec volant manuel  
 Угловой клапан с ручным управлением

Cod./Code	Misura/Size	Attacco/Connection	□/田	€
154003160	3/8"	1/2"	10/60	
154003180	3/8"	24-19	10/60	
154005160	1/2"	1/2"	10/60	
154005180	1/2"	24-19	10/60	
154003162	3/8"	1/2"	10/60	(1)
154003182	3/8"	24-19	10/60	(1)
154005162	1/2"	1/2"	10/60	(1)
154005182	1/2"	24-19	10/60	(1)

### IVR 538 - IVR 538/2



IVR 538

IVR 538/2

- (1) 538/2 - Art. con bocchettone senza autotenuta
- (1) 538/2 - Item with tail piece without auto-seal
- (1) 538/2 - Art. Ventil mit Stutzen ohne Selbstdichtung
- (1) 538/2 - Art. avec raccord non étanche
- (1) 538/2 - Клапан с патрубком без самогерметизации

Dritta con volantino manuale  
 Straight with manual handle  
 Gerade mit Handrad  
 Droite avec volant manuel  
 Прямой клапан с ручным управлением

Cod./Code	Misura/Size	Attacco/Connection	□/田	€
153803160	3/8"	1/2"	10/60	
153803180	3/8"	24-19	10/60	
153805160	1/2"	1/2"	10/60	
153805180	1/2"	24-19	10/60	
153803162	3/8"	1/2"	10/60	(1)
153803182	3/8"	24-19	10/60	(1)
153805162	1/2"	1/2"	10/60	(1)
153805182	1/2"	24-19	10/60	(1)

## VALVOLE PER RADIATORI / RADIATOR VALVES

### Valvole manuali / Manuale valves

#### MERCURY - Detentore attacco PEX/Rame/PEX-AL-PEX / Lockshield PEX/copper/PEX-AL-PEX

Detentore a squadra per radiatori, attacco tubo rame, bocchettone con/senza autotenuta, nichelata  
Angle lockshield, copper connection, with/without auto-seal tail piece, nickel plated  
Eckförmiges, inspektionierbar, für Heizkörper, Anschluss für Kupferrohr, Stutzen mit/ohne Selbstdichtung, vernickelt  
Coude de réglage étanche, fixation à souder pour tube en cuivre, raccord autoétanche ou non étanche, nickelée  
Угловой отсекающий клапан, соединения для стальной трубы, патрубком С / без самогерметизации, никелированный

### IVR 541 - IVR 541/2



A squadra  
Angle lockshield  
Eckförmige Rücklaufverschraubung  
Equerre avec volant manuel  
Угловой клапан

#### IVR 541

#### IVR 541/2

- (1) 541/2 - Art. con bocchettone senza autotenuta
- (1) 541/2 - Item with tail piece without auto-seal
- (1) 541/2 - Art. Ventil mit Stutzen ohne Selbstdichtung
- (1) 541/2 - Art. avec raccord non étanche
- (1) 541/2 - Клапан с патрубком без самогерметизации

Cod./Code	Misura/Size	Attacco/Connection	□/田	€
154103160	3/8"	1/2"	10/120	
154103180	3/8"	24-19	10/120	
154105160	1/2"	1/2"	10/120	
154105180	1/2"	24-19	10/120	
154103162	3/8"	1/2"	10/120	(1)
154103182	3/8"	24-19	10/120	(1)
154105162	1/2"	1/2"	10/120	(1)
154105182	1/2"	24-19	10/120	(1)

### IVR 539 - IVR 539/2



Dritto  
Straight lockshield  
Gerade Rücklaufverschraubung  
Droit  
Прямой клапан

#### IVR 539

#### IVR 539/2

- (1) 539/2 - Art. con bocchettone senza autotenuta
- (1) 539/2 - Item with tail piece without auto-seal
- (1) 539/2 - Art. Ventil mit Stutzen ohne Selbstdichtung
- (1) 539/2 - Art. avec raccord non étanche
- (1) 539/2 - Клапан с патрубком без самогерметизации

Cod./Code	Misura/Size	Attacco/Connection	□/田	€
153903160	3/8"	1/2"	10/120	
153903180	3/8"	24-19	10/120	
153905160	1/2"	1/2"	10/120	
153905180	1/2"	24-19	10/120	
153903162	3/8"	1/2"	10/60	(1)
153903182	3/8"	24-19	10/60	(1)
153905162	1/2"	1/2"	10/60	(1)
153905182	1/2"	24-19	10/60	(1)



## VALVOLE PER RADIATORI / RADIATOR VALVES

Valvole manuali / Manuale valves  
**MERCURY ECO**

### IVR 505 - IVR 505/2

**NEW**



IVR 505

IVR 505/2



LOTTO MINIMO  
 MINIMUM BATCH

- (1) 505/2 - Art. con bocchettone senza autotenuta
- (1) 505/2 - Item with tail piece without auto-seal
- (1) 505/2 - Art. Ventil mit Stutzen ohne Selbstdichtung
- (1) 505/2 - Art. avec raccord non étanche
- (1) 505/2 - Клапан с патрубком без самогерметизации

Mercury ECO, valvola manuale per radiatori, a squadra, attacco tubo ferro, bocchettone con autotenuta, nichelata

Mercury ECO, angle manual radiator valve, iron pipe connection, with auto-seal tail piece, nickel plated

Mercury ECO, eckförmiges Handventil für Heizkörper, Anschluss für Eisenrohr, Stutzen mit Selbstdichtung - vernickelt Mercury

ECO, robinet manuel équerre pour radiateurs, fixation tube fer, raccord autoétanche - nickelée

Mercury ECO, ручной радиаторный клапан, угловой, соединение для стальной трубы, патрубков с самогерметизацией, ни келированный

Cod./Code	Misura/Size	□/田	€
150503000	3/8"	10/60	
150505000	1/2"	10/60	
150503002	3/8"	10/60	(1)
150505002	1/2"	10/60	(1)

### IVR 506 - IVR 506/2

**NEW**



IVR 506

IVR 506/2



LOTTO MINIMO  
 MINIMUM BATCH

- (1) 506/2 - Art. con bocchettone senza autotenuta
- (1) 506/2 - Item with tail piece without auto-seal
- (1) 506/2 - Art. Ventil mit Stutzen ohne Selbstdichtung
- (1) 506/2 - Art. avec raccord non étanche
- (1) 506/2 - Клапан с патрубком без самогерметизации

Mercury ECO, detentore per radiatori, a squadra, attacco tubo ferro, bocchettone con/senza autotenuta, nichelato

Mercury ECO, angle lockshield, iron pipe connection, with/without auto-seal tail piece, nickel plated

Mercury ECO, eckförmige Rücklaufverschraubung für Heizkörper, Anschluss für Eisenrohr, Stutzen mit/ohne Selbstdichtung, vernickelt

Mercury ECO, coude de réglage pour radiateurs, équerre, fixation tube fer, raccord autoétanche ou non étanche, nickelée

Mercury ECO, угловой отсекающий клапан для радиаторов, соединения для стальной трубы, патрубков с/без уплотнения, никелированный

Cod./Code	Misura/Size	□/田	€
150603000	3/8"	1/120	
150605000	1/2"	1/120	
150603002	3/8"	1/120	(1)
150605002	1/2"	1/120	(1)

## IVR 508 - IVR 508/2

NEW



IVR 508

IVR 508/2



LOTTO MINIMO  
MINIMUM BATCH

- (1) 508/2 - Art. con bocchettone senza autotenuta
- (1) 508/2 - Item with tail piece without auto-seal
- (1) 508/2 - Art. Ventil mit Stutzen ohne Selbstdichtung
- (1) 508/2 - Art. avec raccord non étanche
- (1) 508/2 - Клапан с патрубком без самогерметизации

Mercury ECO, valvola manuale per radiatori, a squadra, attacco tubo rame, bocchettone con autotenuta, nichelata

Mercury ECO, angle manual radiator valve, copper connection, with auto-seal tail piece, nickel plated

Mercury ECO, eckförmiges, Handventil für Heizkörper, Anschluss für Kupferrohr, Stutzen mit Selbstdichtung, vernickelt

Mercury ECO, robinet manuel pour radiateurs, équerre, fixation tube cuivre, raccord autoétanche - nickelée

Mercury ECO, ручной радиаторный клапан, угловой, соединения для медной трубы, патрубков с самогерметизацией, никелированный

Cod./Code	Misura/Size	Attacco/Connection	□/田	€
150803160	3/8"	1/2"	10/60	
150805160	1/2"	1/2"	10/60	
150803162	3/8"	1/2"	10/60	(1)
150805162	1/2"	1/2"	10/60	(1)

## IVR 510 - IVR 510/2

NEW



IVR 510

IVR 510/2



LOTTO MINIMO  
MINIMUM BATCH

- (1) 510/2 - Art. con bocchettone senza autotenuta
- (1) 510/2 - Item with tail piece without auto-seal
- (1) 510/2 - Art. Ventil mit Stutzen ohne Selbstdichtung
- (1) 510/2 - Art. avec raccord non étanche
- (1) 510/2 - Клапан с патрубком без самогерметизации

Mercury ECO, detentore per radiatori, a squadra, attacco tubo rame, bocchettone con/senza autotenuta, nichelato

Mercury ECO, angle lockshield, copper connection, with/without auto-seal tail piece, nickel plated

Mercury ECO, eckförmige Rücklaufverschraubung für Heizkörper, Anschluss für Kupferrohr, Stutzen mit/ohne Selbstdichtung, vernickelt

Mercury ECO, coude de réglage pour radiateurs, équerre, fixation tube cuivre, raccord autoétanche ou non étanche, nickelée

Mercury ECO, угловой отсекающий клапан, соединения для медной трубы, патрубков с / без самогерметизации, никелированный

Cod./Code	Misura/Size	Attacco/Connection	□/田	€
151003160	3/8"	1/2"	1/120	
151005160	1/2"	1/2"	1/120	
151003162	3/8"	1/2"	1/120	(1)
151005162	1/2"	1/2"	1/120	(1)

## VALVOLE MANUALI / MANUAL VALVES

Componenti e ricambi / Components and spare parts

### IVR 324



Bocchettone per Saturn e Mercury - Con autotenuta  
Tail piece for Saturn e Mercury - with auto-seal  
Rohrverschraubung für Saturn und Mercury - mit Selbstdichtung  
Raccord pour Saturn et Mercury - avec autoétanche  
Самогерметизирующий патрубок для моделей Saturn и Mercury

Cod./Code	Misura/Size	□/田	€
132403051	3/8" x 1/2"	20/240	
132405071	1/2" x 3/4"	20/240	
132407101	3/4" x 1"	10/120	

### IVR 326



Bocchettone per Saturn e Mercury senza autotenuta - (codolo + calotta)  
Tail piece for Saturn e Mercury with auto-seal (tail piece and nut)  
Rohrverschraubung für Saturn und Mercury mit Selbstdichtung (Verschraubung und Nuss)  
Raccord pour Saturn et Mercury avec autoétanche (queue et calotte)  
Патрубок без самогерметизации для моделей Saturn и Mercury (хвостовая часть с гайкой)

Cod./Code	Misura/Size	□/田	€
132603051	3/8" x 1/2"	20/240	
132605071	1/2" x 3/4"	20/240	
132607101	3/4" x 1"	10/120	
132610121	1" x 1 1/4"	10/160	

### IVR 325



Bocchettone telescopico, nichelato  
Telescopic tail piece, nickel-plated  
Anschluss-Stutzen teleskopisch - vernickelt  
Raccord télescopique - nickelé  
Телескопическое соединение, никелированное

Cod./Code	Misura/Size	□/田	€
132503051	3/8"	20/400	
132505071	1/2"	10/200	
132507101	3/4"	5/100	

## IVR 590



Volantino manuale ABS colore RAL 9010 - per MERCURY, AVANT FLOOR  
 ABS manual handle Ral 9010 colour - for MERCURY, AVANT FLOOR  
 ABS Handrad, RAL9010 - für MERCURY, AVANT FLOOR  
 Volant manuel ABS couleur RAL 9010 - pour MERCURY, AVANT FLOOR -  
 Колпачок для ручной регулировки, ABS цвет Ral 9010 - для MERCURY, AVANT FLOOR

Cod./Code	Misura/Size	□/⊞	€
159000002	3/8" - 1/2"	10/120	

## IVR 586



Cappuccio per detentori - Per detentori MERCURY - MERCURY PLUS - Ottone nichelato  
 Plug for MERCURY lockshield - MERCURY PLUS - nickel-plated brass  
 Kappe für Rücklaufverschraubungen MERCURY - MERCURY PLUS - aus vernickeltem Messing  
 Capuchon pour coude de réglage MERCURY - MERCURY PLUS - en laiton nickelé  
 Заглушка для отсекающего клапана MERCURY - MERCURY PLUS из латуни, никелированная

Cod./Code	Misura/Size	□/⊞	€
158600001	3/8" - 1/2" - 3/4"	10/240	

## IVR 587



Cappuccio per detentori - Per detentori MERCURY - ABS colore Ral 9010  
 Plug for Lockshield - For lockshields MERCURY - ABS color Ral 9010  
 Kappe für Rücklaufverschraubung MERCURY - ABS Farbe Ral 9010  
 Capuchon pour coudes de réglage MERCURY - ABS couleur RAL 9010  
 Крышка для отсекающего клапана MERCURY - ABS, цвет Ral 9010

Cod./Code	Misura/Size	□/⊞	€
158700001	3/8" - 1/2"	10/240	

## IVR 435



Kit valvole manuali a squadra per tubo rame, PEX e multistrato, composto da: valvola e detentore MERCURY, 2+2 DX/SX riduzioni con guarnizione siliconica, valvola scarico aria, tappo ottone con cappuccio bianco

Manual angle radiator valve kit for copper, PEX and multilayer pipe, includes: MERCURY radiator valve and lockshield, 2+2 DX/SX reductions with silicone gasket, manual air vent valve, brass plug with white plastic cap

KIT (Garnitur) manuelles Heizkörperventile, eckförmig für Kupfer-, PEX - und Mehrschichtrohr, bestehend aus: Ventil und Rücklaufverschraubung MERCURY, 2+2 rechts/links, Reduzierstücke mit Silikondichtung, Luftablassventil, Messingdeckel mit weißer Kappe

Kit vannes manuelles équerre pour tube en cuivre, PEX et multicouche, composé de: vanne et coude de réglage MERCURY, 2+2 DX/SX réductions avec joint silicone, vanne d'évacuation de l'air, bouchon en laiton avec capuchon blanc

Комплект ручных угловых клапанов для медной, многослойной и трубы PEX включает: радиаторный клапан и отсекающий клапан Mercury, 2 + 2 пр./лев. футорки с силиконовыми прокладками, ручной воздухоотводчик, заглушки из латуни с белыми пластиковыми колпачками.

Cod./Code	Misura/Size	Attacco/Connection	□/田	€
143503682	3/8"	24-19	1/6	
143505682	1/2"	24-19	1/6	

## IVR 437



Kit universale per radiatori alluminio 1" flangia Ø 42 RAL 9010 composto da: n° 2 DX + n° 2 SX riduzioni con guarnizione siliconica, valvola scarico aria, tappo ottone con cappuccio bianco

Universal kit for aluminum radiators 1" series, Ø 42 flange RAL 9010 includes: n° 2 DX + n° 2 SX reductions with silicone gasket, manual air vent valve, brass plug with white plastic cap

Universalgarnitur für Aluheizkörper, 1" Flansch, Ø 42 RAL 9010, bestehend aus: 2 rechten + 2 linken Reduzierstücke mit Silikondichtung, Entlüftungsventil, Messingdeckel mit weißer Kappe

Kit universel pour radiateurs aluminium 1" bride Ø 42 RAL 9010 composé de: n° 2 DX + n° 2 SX réductions avec joint silicone, vanne d'évacuation de l'air, bouchon en laiton avec capuchon blanc

Универсальный набор для алюминиевых радиаторов 1", фланец Ø 42, RAL 9010 состоящий из: 2+2 пр./лев. футорки с силиконовыми прокладками, воздухоотводчиком, заглушка из латуни с белым пластиковым колпачком

Cod./Code	Misura/Size	Attacco/Connection	□/田	€
143710673	1"	3/8"	1/10	
143710675	1"	1/2"	1/10	

## IVR 438



Kit universale per radiatori alluminio 1" flangia Ø 42 RAL 9010 composto da: n° 2 DX + n° 2 SX riduzioni con guarnizione siliconica, valvola scarico aria, tappo ottone con cappuccio bianco

Universal kit for aluminum radiators 1" series, Ø 42 flange RAL 9010 includes: n° 2 DX + n° 2 SX reductions with silicone gasket, manual air vent valve, brass plug with white plastic cap

Universalgarnitur für Aluheizkörper, 1" Flansch, Ø 42 RAL 9010, bestehend aus: 2 rechten + 2 linken Reduzierstücke mit Silikondichtung, Entlüftungsventil, Messingdeckel mit weißer Kappe

Kit universel pour radiateurs en aluminium 1" bride Ø 42 RAL 9010 composé de: n° 2 DX + n° 2 SX réductions avec joint de silicone, vanne d'évacuation de l'air, bouchon en laiton avec chapeau blanc, couple de supports

Универсальный набор для алюминиевых радиаторов 1", фланец Ø 42, RAL 9010 состоящий из : 2+2 пр./лев. футорки с силиконовыми прокладками, ручной воздухоотводчик, заглушки из латуни с белыми пластиковыми колпачками

Cod./Code	Misura/Size	Attacco/Connection	□/田	€
143810673	1"	3/8"	1/6	
143810675	1"	1/2"	1/6	



## VALVOLE PER RADIATORI / RADIATOR VALVES

Valvole H / H valves

### IVR 753



Valvola "H" con attacco M per impianti bitubo con derivazioni a parete  
 "H" valve with male connection for double pipe systems with wall pipes  
 Zweirohr-Hahnblock Eckform mit AG-Anschluß  
 Pièce "H" avec embout mâle pour systèmes bitube avec dérivation murales  
 Клапан "H" с наружной резьбой, для двухтрубных систем, с возможностью монтажа в стену

Cod./Code	Misura/Size	□/田	€
175307001	3/4"	6/48	

### IVR 754



Valvola "H" con attacco M per impianti monotubo/bitubo (con bypass regolabile 50-100%) con derivazioni a parete  
 "H" valve with male connection for single/double pipe systems (with adjustable bypass 50-100%) with wall pipes  
 Ein-/Zweirohr-Hahnblock (mit regelbarer Bypass 50-100%) Eckform mit AG Anschluß  
 Pièce "H" avec embout mâle pour systèmes monotube/bitube (avec bypass réglable 50-100%) avec dérivation murales  
 Клапан "H" с наружной резьбой для одно/двухтрубных систем (с регулируемым бай-пассом 50-100%) с возможностью монтажа в стену

Cod./Code	Misura/Size	□/田	€
175407001	3/4"	6/48	

### IVR 755



Valvola "H" con attacco M per impianti bitubo con derivazioni a pavimento  
 "H" valve with male connection for double pipe systems with floor pipes  
 Zweirohr-Hahnblock Durchgangsform mit AG Anschluß  
 Pièce "H" avec embout mâle pour systèmes bitube avec dérivation au sol  
 Клапан "H" с наружной резьбой, для двухтрубных систем, с возможностью монтажа в пол

Cod./Code	Misura/Size	□/田	€
175507001	3/4"	6/48	



## IVR 756



Valvola "H" con attacco "M" per impianti monotubo/bitubo (con bypass regolabile 50-100%) con derivazioni a pavimento

"H" valve with male connection for single/double pipe systems (with adjustable bypass 50-100%) with floor pipes

Ein-/Zweirohr-Hahnblock (mit regelbarer Bypass 50-100%) Durchgangsform mit AG Anschluss

Pièce "H" avec embout mâle pour systèmes monotube/bitube (avec bypass réglable 50-100%) avec dérivation au sol

Клапан "H" с наружной резьбой, для одно/двухтрубных систем (с регулируемым бай-пассом 50-100%), с возможностью монтажа в пол

Cod./Code	Misura/Size	□/田	€
175607001	3/4"	6/48	

## IVR 758



Adattatore per valvole "H"

Adapter for "H" valves

Adapter für "H"-Ventile

Adaptateur pour pièces "H"

Адаптер для "H"клапанов

Cod./Code	Misura/Size	□/田	€
175807051	3/4"x1/2"	100/800	



## VALVOLE FAN-COIL / FAN-COIL VALVES

### IVR 748

**NEW**



Valvola fan-coil a 2 vie - attacchi M/M  
Fan-coil 2-way valve - M/M  
2-Wege Kugelhan für Gebläsekonvektoren - AG/AG  
Vanne à 2 voies pour ventilo-convecteurs - M/M  
2-ходовой клапан для фанкойлов ,соединения Н/Н

Cod./Code	Misura/Size	□/田	€
174805001	1/2"	1	
174807001	3/4"	1	
174810001	1"	1	

### IVR 749

**NEW**



Valvola fan-coil a 3 vie - attacchi M/M  
Fan-coil 3-way valve - M/M  
3-Wege Kugelhan für Gebläsekonvektoren - AG/AG  
Vanne à 3 voies pour ventilo-convecteurs - M/M  
3-ходовой клапан для фанкойлов ,соединения Н/Н

Cod./Code	Misura/Size	□/田	€
174905001	1/2"	1	
174907001	3/4"	1	
174910001	1"	1	

### IVR 750

**NEW**



Valvola fan-coil a 4 vie - attacchi M/M  
Fan-coil 4-way valve - M/M  
4-Wege Kugelhan für Gebläsekonvektoren - AG/AG  
Vanne à 4 voies pour ventilo-convecteurs - M/M  
4-ходовой клапан для фанкойлов ,соединения Н/Н

Cod./Code	Misura/Size	□/田	€
175005001	1/2"	1	
175007001	3/4"	1	
175010001	1"	1	

## COMPONENT / COMPONENTS

### Adattatori / Adapters

#### IVR 580



Adattatori preassemblati per tubo rame - Nichelato  
 Adapters preassembled for copper pipe - Nickel plated  
 Eingebaute Zwischenstücke für Kupferrohr - Vernickelt  
 Adaptateurs préassemblés pour tubes en cuivre - Niklé  
 Адаптеры в сборе для медной трубы - Никелированные

Cod./Code	Misura/Size	Attacco/Connection	□/田	€
158005100	10	1/2"	20/200	
158005120	12	1/2"	20/400	
158005140	14	1/2"	20/200	
158005150	15	1/2"	20/400	
158005160	16	1/2"	20/400	
158024100	10	24-19	20/400	
158024120	12	24-19	20/400	
158024140	14	24-19	20/400	
158024150	15	24-19	20/400	
158024160	16	24-19	20/400	
158024180	18	24-19	20/400	
158007120	12	3/4" EK	20/400	
158007140	14	3/4" EK	20/400	
158007150	15	3/4" EK	20/400	
158007160	16	3/4" EK	20/400	
158007180	18	3/4" EK	20/400	

#### IVR 581



Adattatori universali a compressione per tubi multistrato e polietilene reticolato PEX, nichelati  
 Adapters for multilayer pipe and cross-linked polyethylene pipe PEX, nickel plated  
 Universal-Zwischenstücke/Adapter zur Kompressions für Mehrschichtrohre und Rohre aus vernetztem und vernickelt Polyethylen PEX - vernickelt  
 Adaptateurs universels à compression pour tubes multicouche et polyéthylène réticulé PEX - nichelés - nichelés

Никелированные универсальные компрессионные адаптеры для металлопластиковых труб ,труб из сшитого полиэтилена PEX, никелированных труб

Cod./Code	Misura/Size	Attacco/Connection	□/田	€
158105143	14 x 2	1/2"	20/400	
158105156	15 x 2,5	1/2"	20/400	
158105163	16 x 2	1/2"	20/400	
158105164	16 x 2,25	1/2"	20/400	
158124143	14 x 2	24-19	20/400	
158124156	15 x 2,5	24-19	20/400	
158124163	16 x 2	24-19	20/400	
158124164	16 x 2,25	24-19	20/400	
158124173	17 x 2	24-19	20/400	
158124183	18 x 2	24-19	20/400	
158124203	20 x 2	24-19	20/400	
158107143	14 x 2	3/4" EK	20/400	
158107163	16 x 2	3/4" EK	20/300	
158107173	17 x 2	3/4" EK	20/300	
158107183	18 x 2	3/4" EK	20/300	
158107203	20 x 2	3/4" EK	20/300	
158110203	20 x 2	1"	10/150	
158110255	25 x 2,3	1"	10/150	
158110256	25 x 2,5	1"	10/150	
158110268	26 x 3	1"	10/80	

**COMPONENTI / COMPONENTS**  
Centrale termica / Thermal central



**IVR 334**



Gruppo di alimentazione serie pesante per impianti di riscaldamento a circuito chiuso con riduttore di pressione, attacco manometro da 1/4", filtro e rubinetto di intercettazione. Entrata F, uscita M a bocchettone

Automatic filling unit with pressure reducer, 1/4" manometer connection, filter and shut off valve, with inlet F thread and M union connection

Versorgungsgruppe für Heizungssystemen mit geschlossenem Kreislauf mit Druckminderer - schwere Ausführung, Manometeranschluß 1/4", Filter und Absperrventil. Eingang IG und Ausgang AG mit Anschluss-Stutzen (Verschraubung)

Groupe d'alimentation série lourde pour implémentation de chauffage à circuit fermé avec reducteur de pression, fixations manomètre de 1/4", filtre et robinet d'interception. Entrée F sortie M à raccord

Группа подпитки, усиленная версия для закрытых систем отопления, включает редуктор давления, соединение под манометр 1/4", фильтр и перекрывающий клапан. Соединения: В со стороны входа и сгон с накидной гайкой со стороны выхода

Cod./Code	Misura/Size	□/田	€
133405001	1/2"	1/15	

**IVR 336**



Gruppo di alimentazione serie leggera per impianti di riscaldamento a circuito chiuso con riduttore di pressione, attacco manometro da 1/4", filtro e rubinetto di intercettazione. Entrata M a bocchettone, uscita F

Automatic filling unit with pressure reducer, 1/4" manometer connection, filter and shut off valve, with inlet M union connection and F thread

Versorgungsgruppe für Heizungssysteme mit geschlossenem Kreislauf mit Druckminderer - leichte Ausführung, Manometeranschluß 1/4", Filter und Absperrventil. Eingang (IG) und Ausgang (AG) mit Anschluss-Stutzen (Verschraubung)

Groupe d'alimentation série légère pour implémentation de chauffage à circuit fermé avec reducteur de pression, Fixations manomètre de 1/4", filtre et robinet d'interception. Entrée M raccord, sortie F

Группа подпитки, облегченная версия, для закрытых систем отопления, включает редуктор давления, соединение под манометр 1/4", фильтр и перекрывающий клапан. Соединения: патрубок с накидной гайкой со стороны входа и В со стороны выхода

Cod./Code	Misura/Size	□/田	€
133605001	1/2"	1/25	

**IVR 358**



Manometro diametro 50 - 63 mm - attacco radiale Per IVR 334 - 336

Radial pressure gauge circle 50 - 63 mm. For IVR 334 - 336

Manometer Ø 50 - 63 mm - Anschluss unten, für IVR 304

Manometre Ø 50 - 63mm - fixation radiale pour ivr 304

Радиальный манометр 50-63 мм. Для IVR 334 - 336

Cod./Code	Misura/Size	□/田	€
135802116	1/4" Ø 50 - scala/scale 0-16 bar	1/100	
135802206	1/4" Ø 63 - scala/scale 0-6 bar	1/100	
135802210	1/4" Ø 63 - scala/scale 0-10 bar	1/100	
135802216	1/4" Ø 63 - scala/scale 0-16 bar	1/100	

## COMPONENTI / COMPONENTS

### Valvole di bilanciamento / Balancing valves

#### IVR 340



Valvola in ottone DZR ad orifizio fisso, filettata F/F (ISO 228/1 per DN15/20, ISO7/1 Rp oltre). Brugola di preimpostaggio in dotazione. Condizioni di esercizio: da -10° C a +130° C

Fixed orifice DZR brass double reg. valve, threaded F/F (ISO 228/1 for DN15/20, ISO7/1 Rp above). Valve supplied with allen key for setting. Working conditions: -10°C to +130° C

Ventil aus DZR-Messing mit fester Öffnung, alle Anschlüsse mit Innengewinde (ISO 228/1 für DN15/20, ISO7/1 Rp höher). Ausstattung mit Inbusschlüssel zur Voreinstellung. Betriebstemperatur von -10° C zu + 130° C

Vanne d'équilibrage statique en laiton DZR, orifice fixe, fileté F/F (ISO 228/1 pour DN15 / 20, ISO7 / Rp 1 au-dessus). Valve fourni avec une clé Allen pour le réglage. Conditions de travail: -10° C à + 130° C

Балансировочный клапан из латуни марки DZR, фиксированное отверстие, резьбовое соединение В/В (ISO 228/1 для DN15/20, ISO7/1). Клапан поставляется с ключом для регулировки. Рабочая температура от -10° C до +130° C

Cod./Code	Misura/Size	□/田	€
134005001	1/2"	4/16	
134007001	3/4"	5/20	
134010001	1"	4/16	
134012001	1"1/4	4/16	
134015001	1"1/2	2/8	
134020001	2"	2/8	

#### IVR 342



Valvola in ghisa a doppia reg. con prese di pressione in DZR (non montate), ad orifizio variabile, flangiata PN16 (EN1092-2). Condizioni di esercizio: da -10° C a +120° C

Cast iron double setting valve with test points in DZR brass (unmounted), variable orifice, Flangiata PN16 (EN1092-2). Working conditions: -10° C to +120° C

Ventil aus Gusseisen - Doppelseinstellung mit DZR Drucksteckdose (nicht eingebaut), mit veränderbarer Öffnung, Flansch PN16 (EN 1092-2). Betriebstemperatur: -10° C to +120° C

Vanne d'équilibrage statique en fonte, avec prises de pression pas montée, orifice variable, pourvue de brides PN16 (EN1092-2). Conditions de travail: -10° C à + 120° C

Чугунный клапан с двойной регулировкой, вставки для контроля из латуни DZR (не установлены), фланцы PN16 (EN1092-2). Рабочая температура: от -10° C до +120° C

Cod./Code	Misura/Size	□/田	€
134225001	dn 65	1	
134230001	dn 80	1	
134240001	dn 100	1	
134250001	dn 125	1	
134260001	dn 150	1	
134280001	dn 200	1	
134290001	dn 250	1	
134295001	dn 300	1	

#### IVR 341



Valvola in bronzo ad orifizio variabile, filettata F/F ISO 228/1, brugola di preimpostaggio in dotazione. Condizioni di esercizio da -10° a +130°

Bronze valve with variable orifice, F/F ISO 228/1 threaded unions, supplied with Allen key for setting. Working temperatures: -10 +130°

Ausgleichventil aus Rotguss mit veränderbarer Öffnung, IG/IG Gewinde ISO 228/1, geliefert mit dem Inbusschlüssel zur Voreinstellung. Betriebstemperaturen: -10° +130°

Vanne en bronze avec orifice variable, filetage F/F ISO 228/1, fournie avec la clé Allen pour le réglage. Températures de fonctionnement: -10° +130°

Бронзовый клапан с вариационным отверстием, резьбовое соединение В/В ISO 228/1, поставляется с установочным ключом. Условия эксплуатации от -10 ° до + 130 °

Cod./Code	Misura/Size	□/田	€
134105001	1/2"	4/16	
134107001	3/4"	5/20	
134110001	1"	4/16	
134112001	1"1/4	4/16	
134115001	1"1/2	2/8	
134120001	2"	2/8	

## IVR 344

NEW



Valvola di bilanciamento automatico in ottone DZR con bocchettoni filettata F/F ISO 7/1 RP condizioni di esercizio da -10° a +130°

Automatic balancing valve in DZR brass with tail piece F/F ISO 7/1 RP thread working temperatures -10° +130°

Automatisches Ausgleichsventil aus DZR-Messing mit Rohrverschraubungen Gewinde IG/IG ISO 7/1 RP Betriebstemperaturen -10° +130°

Vanne d'équilibrage en laiton DZR avec raccord de tuyauterie température de fonctionnement -10° +130°

Автоматический балансировочный клапан из латуни DZR, со сгоном ,резьбовые соединения В/В ISO 7/1 RP . Условия эксплуатации от -10 ° до + 130 °

Cod./Code	Misura/Size	□/田	€
134405001	1/2"	4/16	
134407001	3/4"	5/20	
134410001	1"	4/16	
134412001	1"1/4	4/16	
134415001	1"1/2	2/8	
134420001	2"	2/8	

## IVR 344/C

NEW



Cartuccia stabilizzatrice di portata per valvola di bilanciamento automatico

Cartridge for the stabilisation of water flow for automatic balancing

Kartusche zur Stabilisierung des Wasserflusses für automatischen Ausgleich

Cartouche de stabilisation du débit pour la vanne d'équilibrage automatique

Картридж стабилизации потока для автоматического балансировочного клапана

### DN15 - DN20 - DN25

Cod./Code	Range ΔP	l/h	□/田	€
134452001	17 - 240 kPa	468	1	
134452002	17 - 240 kPa	540	1	
134452003	17 - 240 kPa	612	1	
134452004	17 - 240 kPa	684	1	
134452011	18 - 240 kPa	756	1	
134452012	18 - 240 kPa	864	1	
134452013	18 - 240 kPa	972	1	
134452014	18 - 240 kPa	1080	1	
134452015	18 - 240 kPa	1188	1	
134452016	18 - 240 kPa	1296	1	
134452017	18 - 240 kPa	1440	1	
134452021	19 - 240 kPa	1620	1	
134452022	19 - 240 kPa	1800	1	
134452031	21 - 240 kPa	1980	1	
134452041	22 - 240 kPa	2160	1	
134452051	24 - 240 kPa	2376	1	
134452052	24 - 240 kPa	2592	1	

### DN32 - DN40 - DN50

Cod./Code	Range ΔP	l/h	□/田	€
134453001	13 - 230 kPa	1116	1	
134453002	13 - 230 kPa	1224	1	
134453003	13 - 230 kPa	1332	1	
134453011	14 - 230 kPa	1440	1	
134453012	14 - 230 kPa	1656	1	
134453013	14 - 230 kPa	1800	1	
134453014	14 - 230 kPa	1980	1	
134453015	14 - 230 kPa	2088	1	
134453016	14 - 230 kPa	2232	1	
134453021	15 - 230 kPa	2412	1	
134453022	15 - 230 kPa	2664	1	
134453023	15 - 230 kPa	2988	1	
134453024	15 - 230 kPa	3240	1	
134453025	15 - 230 kPa	3492	1	
134453026	15 - 230 kPa	3780	1	
134453027	15 - 230 kPa	4320	1	
134453031	16 - 230 kPa	4680	1	
134453041	17 - 230 kPa	5184	1	
134453042	17 - 230 kPa	5616	1	
134453051	18 - 230 kPa	6048	1	
134453061	19 - 230 kPa	6480	1	
134453062	19 - 230 kPa	7056	1	



## IVR 346



Prese di pressione, filettata M 1/4" ISO 7/1 R in ottone DZR  
 Pressure test point, M 1/4" ISO 7/1 R in DZR brass  
 Drucksteckdose, Außengewinde 1/4" ISO 7/1 R aus DZR-Messing  
 Prises de pression, filetée M 1/4" ISO 7/1 R en laiton DZR  
 Точка контроля давления, соединения H 1/4" ISO 7/1 R, латуны марки DZR

Cod./Code	Misura/Size	□/田	€
134610201	1/4" presa press cravatta blu	10	
134610202	1/4" presa press cravatta ros	10	
134630201	1/4" kit pr press c/prol crav blu	10	
134630202	1/4" kit pr press c/prol crav ros	10	

## COMPONENTI / COMPONENTS

Gruppi valvole di Sicurezza e scarico caldaia / Safety Valves

## IVR 718



Gruppo di sicurezza caldaia in ottone; valvola di intercettazione; manometro; scarico aria automatico; valvola di sicurezza

Brass safety set; automatic shut-off valve; pressure gauge; automatic air-vent; safety valve

Sicherheitsgruppe für Heizkessel aus Messing; Abfang / Absperrventil; Manometer; automatisches Entlüftung; Sicherheitsventil

Groupe de sécurité chaudière en laiton, vanne d'interception, manometre; sortie aire automatique; vanne de sécurité

Группа безопасности котла латунная, отсекающий кран, манометр, автоматический воздухоотводчик, предохранительный клапан

Cod./Code	Misura/Size	□/田	€
171810020	1" - 2,0 bar	1/7	
171810025	1" - 2,5 bar	1/7	
171810030	1" - 3,0 bar	1/7	
171810040	1" - 4,0 bar	1/7	
171810050	1" - 5,0 bar	1/7	

## IVR 718/C



Guscio di coibentazione per GRUPPO SAFETY

Isolating element for SAFETY SET

Isolierhülse für SAFETY SET

Coque isolante pour GROUPE SAFETY

Изолирующий элемент для ГРУППЫ БЕЗОПАСНОСТИ

Cod./Code	Misura/Size	□/田	€
335800421	Guscio / Coibent	1	

## IVR 355



Valvola di sicurezza M/F  
Safety valve M/F  
Sicherheitsventile AG/IG  
Soupape de sécurité M/F  
Предохранительный клапан H/B

Cod./Code	Misura/Size	□/田	€
135505151	1/2" 1.5 Bar	10/100	
135505201	1/2" 2 Bar	10/100	
135505251	1/2" 2.5 Bar	10/100	
135505301	1/2" 3 Bar	10/100	
135505401	1/2" 4 Bar	10/100	
135505501	1/2" 5 Bar	10/100	
135505601	1/2" 6 Bar	10/100	

## IVR 356



Valvola di sicurezza M/F - con attacco manometro 1/4"  
Safety valve M/F - with manometer connection 1/4"  
Sicherheitsventile AG/IG - mit manometeranschluss 1/4"  
Soupape de sécurité M/F - avec fixations pour le manomètre 1/4  
Предохранительный клапан В/Н - с соединением для манометра 1/4"

Cod./Code	Misura/Size	□/田	€
135605151	1/2" 1.5 Bar	10/100	
135605201	1/2" 2 Bar	10/100	
135605251	1/2" 2.5 Bar	10/100	
135605301	1/2" 3 Bar	10/100	
135605401	1/2" 4 Bar	10/100	
135605501	1/2" 5 Bar	10/100	
135605601	1/2" 6 Bar	10/100	

## IVR 350



Valvola di sicurezza F/F  
Safety valve F/F  
Sicherheitsventile IG/IG  
Soupape de sécurité F/F  
Предохранительный клапан В/В

Cod./Code	Misura/Size	□/田	€
135005151	1/2" 1.5 Bar	10/150	
135005201	1/2" 2 Bar	10/150	
135005251	1/2" 2.5 Bar	10/150	
135005301	1/2" 3 Bar	10/150	
135005401	1/2" 4 Bar	10/150	
135005501	1/2" 5 Bar	10/150	
135005601	1/2" 6 Bar	10/150	
135007151	3/4" 1.5 Bar	10/140	
135007201	3/4" 2 Bar	10/140	
135007251	3/4" 2.5 Bar	10/140	
135007301	3/4" 3 Bar	10/140	
135007401	3/4" 4 Bar	10/140	
135007501	3/4" 5 Bar	10/140	
135007601	3/4" 6 Bar	10/140	
135010151	1" 1.5 Bar	10/60	
135010201	1" 2 Bar	10/60	
135010251	1" 2.5 Bar	10/60	
135010301	1" 3 Bar	10/60	
135010401	1" 4 Bar	10/60	
135010501	1" 5 Bar	10/60	
135010601	1" 6 Bar	10/60	

## IVR 351

**NEW**



Valvola di sicurezza F/F - con attacco manometro 1/4"  
 Safety valve F/F with manometer connection  
 Sicherheitsventil IG/IG mit Druckmesseranschluss  
 Soupape de sécurité F/F avec fixation manomètre  
 Предохранительный клапан В/В - с соединением для манометра 1/4"

Cod./Code	Misura/Size	□/田	€
135105151	1/2" 1.5 Bar	10/150	
135105201	1/2" 2 Bar	10/150	
135105251	1/2" 2.5 Bar	10/150	
135105301	1/2" 3 Bar	10/150	
135105401	1/2" 4 Bar	10/150	
135105501	1/2" 5 Bar	10/150	
135105601	1/2" 6 Bar	10/150	

## IVR 347

**NEW**



Valvola di sicurezza doppia funzione - temperatura e pressione attacchi filettati MF  
 Double-use safety valve - temperature and pressure M/F  
 Sicherheitsventil mit doppeltem Einsatz - Temperatur und Druck, AG/IG  
 Soupape de sécurité avec double fonction - température et pression, M/F  
 Двухфункциональный предохранительный клапан (температура и давление), резьбовые соединения Н/В

Cod./Code	Misura/Size	T°	PN	□/田	€
134705053	1/2" x 1/2"	90 °C	3 bar	1/24	
134705054	1/2" x 1/2"	90 °C	4 bar	1/24	
134705056	1/2" x 1/2"	90 °C	6 bar	1/24	
134705057	1/2" x 1/2"	90 °C	7 bar	1/24	
134705058	1/2" x 1/2"	90 °C	8 bar	1/24	
134707053	3/4" x 1/2"	90 °C	3 bar	1/24	
134707054	3/4" x 1/2"	90 °C	4 bar	1/24	
134707056	3/4" x 1/2"	90 °C	6 bar	1/24	
134707057	3/4" x 1/2"	90 °C	7 bar	1/24	
134707058	3/4" x 1/2"	90 °C	8 bar	1/24	
134707073	3/4" x 3/4"	90 °C	3 bar	1/24	
134707074	3/4" x 3/4"	90 °C	4 bar	1/24	
134707076	3/4" x 3/4"	90 °C	6 bar	1/24	
134707077	3/4" x 3/4"	90 °C	7 bar	1/24	
134707078	3/4" x 3/4"	90 °C	8 bar	1/24	

## IVR 354

**NEW**



Valvola di sicurezza doppia funzione - temperatura e pressione attacchi M e raccordo a bicono per tubo rame  
 Double-use safety valve - temperature and pressure M and copper compression connection  
 Sicherheitsventil mit doppeltem Einsatz - Temperatur und Druck, AG und Kupfer-Kompressionsverbindung  
 Soupape de sécurité avec double fonction - température et pression, M et raccord à compression pour tube en cuivre  
 Двухфункциональный предохранительный клапан - (температура и давление), Наружный фитинг с двойным конусом для медной трубы

Cod./Code	Misura/Size	T°	PN	□/田	€
135405153	1/2" x 15	90 °C	3 bar	1/24	
135405154	1/2" x 15	90 °C	4 bar	1/24	
135405156	1/2" x 15	90 °C	6 bar	1/24	
135405157	1/2" x 15	90 °C	7 bar	1/24	
135405158	1/2" x 15	90 °C	8 bar	1/24	
135407153	3/4" x 15	90 °C	3 bar	1/24	
135407154	3/4" x 15	90 °C	4 bar	1/24	
135407156	3/4" x 15	90 °C	6 bar	1/24	
135407157	3/4" x 15	90 °C	7 bar	1/24	
135407158	3/4" x 15	90 °C	8 bar	1/24	
135407223	3/4" x 22	90 °C	3 bar	1/24	
135407224	3/4" x 22	90 °C	4 bar	1/24	
135407226	3/4" x 22	90 °C	6 bar	1/24	
135407227	3/4" x 22	90 °C	7 bar	1/24	
135407228	3/4" x 22	90 °C	8 bar	1/24	

## IVR 369

NEW



Valvola di sicurezza a squadra a tenuta metallica  
Angle safety valve with metallic sealing  
Eckförmiges Sicherheitsventil mit Metalledichtung  
Soupape de sécurité équerre avec obturateur métallique  
Угловой предохранительный клапан с металлическим уплотнением

Cod./Code	Misura/Size	□/田	€
136905001	1/2"	50	
136907001	3/4"	40	
136910001	1"	25	
136912001	1" 1/4	15	
136915001	1" 1/2	10	
136920001	2"	5	

## IVR 352

NEW



Valvola di sicurezza per scaldabagni - tipo leggero  
Safety valve for water heaters - light version  
Sicherheitsventil für Wasserkessel - leichte Ausführung  
Soupape de sécurité pour chauffe eau - variante légère  
Предохранительный клапан для водонагревателей - облегченная версия

Cod./Code	Misura/Size	□/田	€
135205001	1/2"	300	

## IVR 352/L

NEW



Valvola di sicurezza con leva per scaldabagni - tipo leggero  
Safety valve for water heaters - light version  
Sicherheitsventil für Wasserkessel - leichte Ausführung  
Soupape de sécurité pour chauffe eau - variante lourde  
Предохранительный клапан с ручкой "флажок" для водонагревателей - облегченная версия

Cod./Code	Misura/Size	□/田	€
135205002	1/2"	250	

## IVR 353

NEW



Valvola di sicurezza per scaldabagni - tipo pesante  
Safety valve for water heaters - heavy version  
Sicherheitsventil für Wasserkessel - schwere Ausführung  
Soupape de sécurité pour chauffe eau - variante lourde  
Предохранительный клапан для водонагревателей - усиленная версия

Cod./Code	Misura/Size	□/田	€
135305001	1/2"	200	

## IVR 353/L

**NEW**



Valvola di sicurezza con leva per scaldabagni - tipo pesante  
 Safety valve for water heaters - heavy version  
 Sicherheitsventil für Wasserkessel - schwere Ausführung  
 Soupape de sécurité pour chauffe eau - variante lourde  
 Предохранительный клапан с ручкой "флажок" для водонагревателей - усиленная версия

Cod./Code	Misura/Size	□/田	€
135305002	1/2"	150	

## IVR 103



Rubinetto per scarico caldaia serie pesante con quadro di manovra e cappuccio con chiave incorporata; attacco F

Heavy boiler blow-off valve. Fastenings F - hose connect

KFE-Hahn - schwere Ausführung - mit Schalttafel und Kappe mit integriertem Schlüssel - Anschluss IG

Robinet d'évacuation chaudière série lourde avec tableau de manoeuvre et capuchon à clé intégrée - fixation F

Усиленный сливной клапан для котла тяжелой серии с квадратной управляющей головкой и крышкой со встроенным ключом. Соединение B

Cod./Code	Misura/Size	∅	□/田	€
110305001	1/2"x3/4"	10	10/60	
110307001	3/4"x1"	15	10/60	
110310001	1"	25	10/60	

## IVR 105



Rubinetto per scarico caldaia serie pesante con quadro di manovra e cappuccio con chiave incorporata attacco M

Heavy boiler blow-off valve. Fastenings M - hose connect

KFE-Hahn - schwere Ausführung - mit Schalttafel und Kappe mit integriertem Schlüssel - Anschluss AG

Robinet d'évacuation chaudière série lourde avec tableau de manoeuvre et capuchon à clé intégrée - fixation M

Усиленный сливной клапан для котла тяжелой серии с квадратной управляющей головкой и крышкой со встроенным ключом. Соединение H

Cod./Code	Misura/Size	∅	□/田	€
110505001	1/2"x3/4"	10	10/60	
110507001	3/4"x1"	15	10/60	
110510001	1"	25	10/60	

## IVR 904



Rubinetto per scarico caldaia completo di tappo; attacchi M - portagomma - leva nera

Boiler blow-off valve complete with hose tail and plug - Fastenings M - hose connect - black handle

KFE-Hahn mit Deckel - Anschlüsse AG - Schlauchanschluss - schwarzer Griff

Robinet d'évacuation chaudière avec bouchon - fixations M - porte tuyau souple - Poignée noire

Сливной кран для котла в комплекте с заглушкой и соединением под шланг. Соединение H - черная ручка-флажок

Cod./Code	Misura/Size	∅	□/田	€
190403001	3/8"x3/4"	8	40/160	
190405001	1/2"x3/4"	10	40/160	
190407001	3/4"x1"	15	20/100	

## IVR 905



Rubinetto per scarico caldaia completo di tappo; attacchi M - portagomma - leva rossa e guarnizione di tenuta

Boiler blow-off valve complete with hose tail and plug - Fastenings M - hose connect - red handle and seal

KFE-Hahn mit Deckel - Anschlüsse AG - Schlauchanschluss - roter Griff und Dichtung

Robinet d'évacuation chaudière avec bouchon - fixations M - porte tuyau souple - poignée rouge et joint étanchéité

Сливной кран для котла в комплекте с заглушкой и соединением под шланг. Соединение Н - красная ручка-флажок и прокладка

Cod./Code	Misura/Size	Ø	□/⊞	€
190505001	1/2"x3/4"	10	20/100	

## IVR 62



Rubinetto per scarico caldaia serie pesante, con tappo, attacco F

Heavy boiler blow-off valve. F threads with plug

KFE-Hahn schwere Ausführung mit Kappe Anschluss IG

Robinet d'évacuation chaudière type lourd fixation F et bouchon

Сливной кран для котла тяжелой серии, с заглушкой, соединение В

Cod./Code	Misura/Size	□/⊞	€
106205001	1/2" scarico caldaia Fem Nic	10/120	
106205011	1/2" scarico caldaia Fem Gia	10/120	

## IVR 64



Rubinetto per scarico caldaia serie pesante, con tappo, attacco M

Heavy boiler drain valve with cap and M connection

KFE-Hahn mit Kappe - Anschluss AG

Robinet d'évacuation chaudière type lourd avec bouchon - fixation M

Сливной кран для котла тяжелой серии, с заглушкой, соединение Н

Cod./Code	Misura/Size	□/⊞	€
106405001	1/2" scarico caldaia Mas Nic	10/120	
106405011	1/2" scarico caldaia Mas Gia	10/120	



## IVR 149

**NEW**



Rubinetto porta manometro M/F con premistoppa e foro di spurgo, maniglia termoplastica  
 Manometer holder M/F with packing nut and drain hole, handle in thermoplastic  
 Manometerhalter AG/IG mit Stopfbüchse und Ablassbohrung und Griff aus Thermoplastik  
 Robinet porte-manomètre M/F avec presse-étoupe et purge, poignée en thermoplastique  
 Кран для установки манометра, соединения Н/В, с сальником, выпускным отверстием, термопластиковая ручка

Cod./Code	Misura/Size	□/田	€
114902001	1/4"	10/60	
114903001	3/8"	10/60	
114905001	1/2"	10/60	

## IVR 150

**NEW**



Rubinetto porta manometro M/F con premistoppa, flangia e tappo su flangia e foro di spurgo, maniglia termoplastica

Manometer holder M/F with packing nut, flange and cap on the flange, handle in thermoplastic  
 Manometerhalter AG/IG mit Stopfbüchse, Flansche und Deckel auf der Flansche, Griff aus Thermoplastik  
 Robinet porte-manomètre M/F avec presse-étoupe, bride et bouchon sur la bride, poignée en thermoplastique

Кран для установки манометра, соединения Н/В, с сальником, выпускным отверстием, фланцем и заглушкой на фланце, термопластиковая ручка

Cod./Code	Misura/Size	□/田	€
115002001	1/4"	10/60	
115003001	3/8"	10/60	
115005001	1/2"	10/60	